

Power PostTM Control Panel

Pump Connection Center | Timed or Demand Dose, Integrated Alarm

USER GUIDE

PART/MODEL NUMBERS:

PPCP Series

(Models: PPRS-0001 and PPRS-0002)

Alderon IndustriesTM | Patent Pending



Power Post™ Control Panel - USER GUIDE

Contents

Introduction	3
Safety and System Guidelines	3
Product Included	4
Features	5
Installation	6
Installing Post	6, 7
Wiring	7, 8
Testing	9
Final Installation	10, 11
Removable Control Relay Installation	11
Basic System Functions	12
System Power, Menu, and Event Displays	12
Hand-Off-Auto and System Override	13
Timed or Demand Dosing	13
Pump Run and Total Gallons Pumped	14
Pump Alarms	15, 16
Timed Dose On and Timed Dose Off	17
Peak Dose On, Peak Dose Off, and Minimum Peak Doses	18, 19
Auxiliary Alarms	20, 21
System Alarms	22-24
System Override Event	25
System Functions Events, Statistics, Settings, and Menu	26
Basic System Functions and Event Displays	26
Statistic Value Displays	26
Product Label Examples	27
1.0, 2.0, 3.0, 4.0, and 5.0 Menu System - Main Menu	28
1.0 Main Menu - Hand-Off-Auto Pump Mode Selector	29
2.0 Main Menu - Resettable History	30
3.0 Main Menu - Settings (illustration only)	31
3.0 Main Menu - Settings	32-34
4.0 Main Menu - Lifetime History	35
5.0 Main Menu - Model Name and Firmware	36
6.0 Event Displays	36
2.1 Resettable History - Pump Run Stats	37
2.2 Resettable History - Extended Pump Run Stats	38
2.3 Resettable History - High Amp Stats	39
2.4 Resettable History - Pump Float Stats	40
2.5 Resettable History - Relay Stats	40
2.6 Resettable History - Dose On Stats	41
2.7 Resettable History - Peak On Stats	42
2.8 Resettable History - High Level Alarm Stats	43
2.9 Resettable History - Filter Alarm Stats	44
2.10 Resettable History - Pump Fail Stats	45
2.11 Resettable History - Relay Fail Stats	46
2.12 Resettable History - System Fail Stats	47
2.13 Resettable History - Power Loss Stats	47
4.1 Lifetime History - Pump Run Stats	48
4.2 Lifetime History - Extended Pump Run Stats	49
4.3 Lifetime History - High Amp Stats	50
4.4 Lifetime History - Pump Float Stats	51
4.5 Lifetime History - Relay Stats	51
4.6 Lifetime History - Dose On Stats	51
4.7 Lifetime History - Peak On Stats	52
4.8 Lifetime History - High Level Alarm Stats	53
4.9 Lifetime History - Filter Alarm Stats	54
4.10 Lifetime History - Pump Fail Stats	55
4.11 Lifetime History - Relay Fail Stats	56
4.12 Lifetime History - System Fail Stats	57
4.13 Lifetime History - Power Loss Stats	57
Menu System Flow (text only)	58, 59
General Operation	59
Septic Tank Monitoring Control and Filter Switch Operated (demand dose)	60
Septic Tank Monitoring Pump, Control, and Filter Switch Operated (demand dose)	61
Septic Tank Monitoring Control and Filter Switch Operated (timed dose)	62
Troubleshooting	63, 64
Specifications	65
Model Number Nomenclature	66
Warranty Information	67
Company Information	68

Introduction

Use the Power Post™ Control Panel to make a professional and safe connection for power and float switch wiring connections to your on-site septic system. The Power Post™ eliminates a 4" x 4" wood post and the exposed wires for a safe, clean, and quick installation. This system can be used for a wide variety of timed or demand dose applications, including but not limited to: mound systems, pressurized drain fields, or any system requiring timed or demand dose pumping and monitoring. Available models include 120VAC and 240VAC.

The Power Post™ Control Panel has an integrated outdoor alarm equipped with LED indicators (various colors), buzzer, and test/silence pushbutton. The top of the enclosure cover changes color along with system function displayed text on the OLED screen for easy troubleshooting information. Menu keys are provided to program settings and view data such as: pump cycle counts, pump amps, elapsed time, total gallons pumped, pump dosing events, alarm conditions, and more.

The system includes terminals to connect a pump control float switch, high level alarm float switch, and filter switch. Use the auxiliary alarms for monitoring high liquid level and service of the effluent filter.

Safety Guidelines

Before proceeding with the installation or operation of this product, read all instructions thoroughly, as well as complying with all federal, state and local codes, regulations, and practices. This product must be installed by qualified personnel familiar with all applicable local electrical and mechanical codes. Refer to the National Electrical Code (NFPA 70). Failure to properly install and test this product can result in personal injury or equipment malfunction.



1. DISCONNECT POWER when installing or servicing the product. Failure to disconnect all power sources could result in serious injury or death.
2. NEVER enter a flooded space without proper Personal Protective Equipment (PPE). Always wear dielectric rubber boots and other applicable protective equipment when water is on the floor and you must service an energized pump, alarm system, or product.
3. DO NOT enter the water if the water level is higher than that of the protection your PPE offers or if your PPE is not watertight.
4. DO NOT use this product with or near flammable liquids.
5. DO NOT install this product in locations classified as hazardous or in explosive atmospheres as defined by any applicable electrical safety code.

System Guidelines

CAUTION: Before proceeding with the operation of this product, Alderon™ recommends changing the factory settings to customize the system per application for desired operation. See pages 31-34 for complete system settings information.

1. SILENCE TIME - Length of time the alarm buzzer will silence after the test/silence pushbutton is pressed.
2. EXTENDED PUMP RUN TIME - Allowable time for pump to run continuously for longer than configured amount of time.
3. HIGH AMP LEVEL - Acceptable level of current sensed on the pump input during a pump run event.
4. GALLONS PER MINUTE - Perform manual test to determine value entered, when set to zero no statistics are displayed.
5. DEMAND or TIMED DOSE - Configure system to either demand dose or timed dose per application.
6. ON TIME or OFF TIME - Set duration of on and off times for normal and peak timed dosing per application.
7. MINIMUM PEAK DOSES - Set amount of peak dose cycles to run during peak system operation in timed dosing.
8. BUZZER DELAY - Delays time the alarm buzzer will annunciate after a high level alarm event is activated in timed dosing.

Power Post™ Control Panel - USER GUIDE

Product Included

This model includes: (1) Power Post™ Control Panel, (1) Pump Power Receptacle (120VAC or 240VAC, voltage depends on model/part number), and (2) Wago connectors.

(1) Power Post™ Control Panel

The Power Post™ comes with a 42.5-inch post to install in the ground. The ventilated post cap, cable grips, and junction box are all pre-installed to the post.

(2) Pump Power Receptacle

A female power receptacle is pre-installed, rated at 15 Amps. Available in 120VAC or 240VAC models.

(3) Wago Connector

Two Wago connectors are included and pre-installed on the pump power receptacle for making wire terminations.

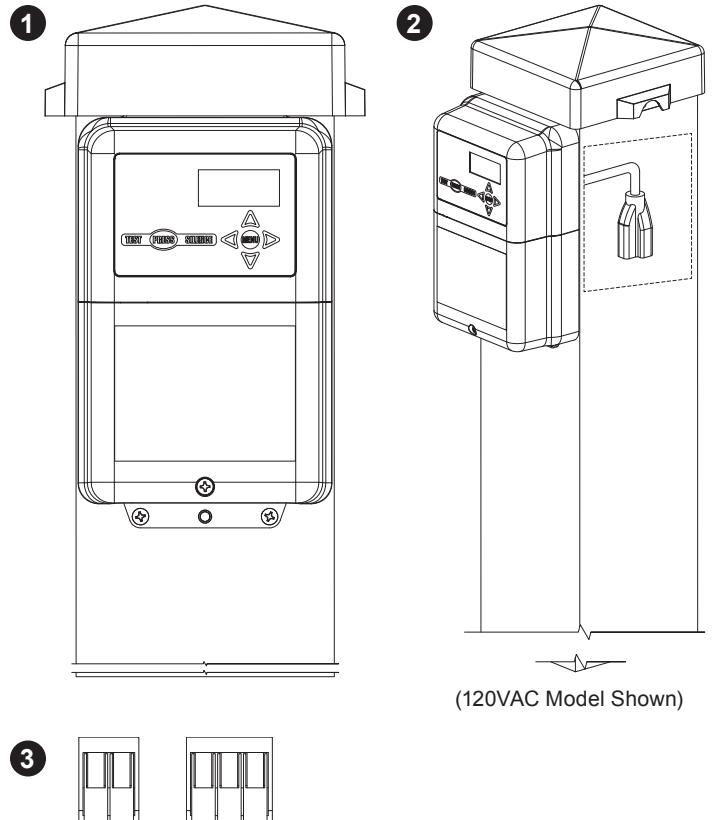

(120VAC Model Shown)

ADDITIONAL OPTIONS:

(4) Alarm or Pump Control Float Switch

The alarm float switch is a typical sensor expected to be used with the Power Post™ for liquid level monitoring. The pump control float switch is a typical sensor to be used with the Power Post™ to control the operation of the pump.

(5) In-Line Pump Float Switch (optional)

The in-line pump float switch is connected in-line with the pump power to control the pump directly. When actuated the in-line pump float switch will pass power to the pump.

(6) Filter Switch

The filter switch is used to activate an alarm when a septic tank effluent filter needs to be serviced and is universal to any brand of effluent filter that has a one-inch through hole.

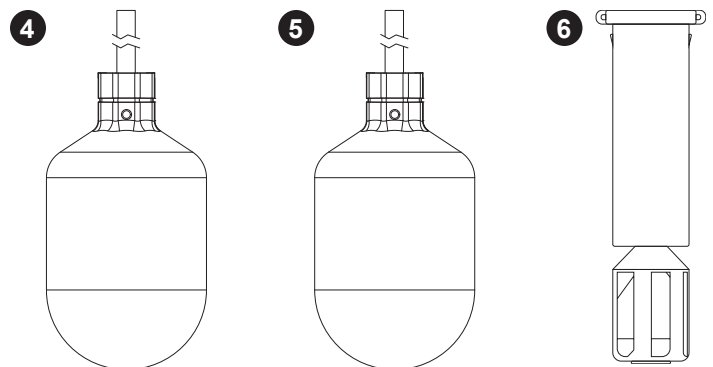

Features

Refer to the illustration below to reference the feature descriptions provided.

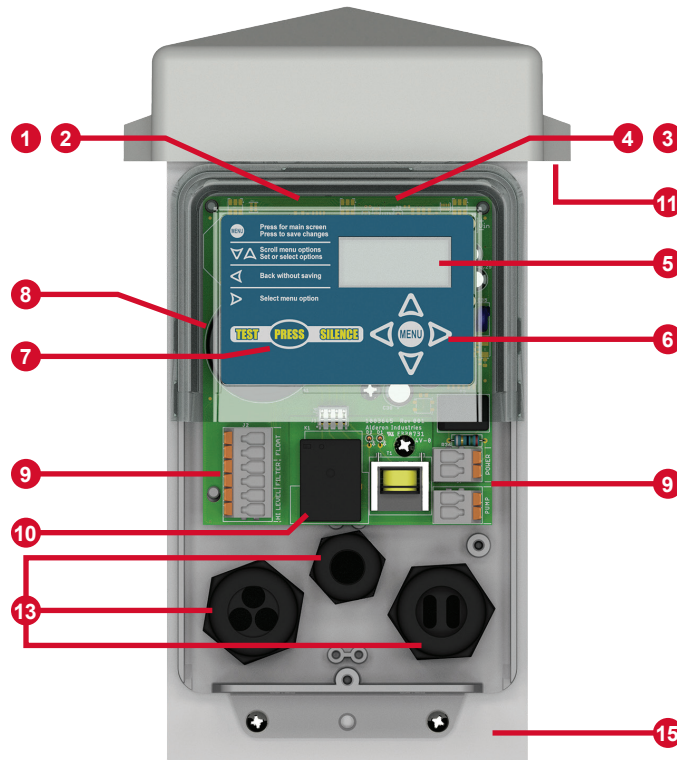

(1) Power On Indicator - Green LEDs will illuminate inside the top cover of the enclosure to indicate that the unit is powered on. Note: The power on LED indicators can be disabled in system settings, see page 32.

(2) Alarm Beacon - During an alarm condition, the green power on indicator will turn off and alarm LEDs (various colors) will illuminate, flashing inside the top cover of the enclosure, see pages 15-26.

(3) Pump Run Indicator - When the pump is running under normal conditions, the blue LED indicator will illuminate inside the top cover of the enclosure. Note: The pump run LED indicators can be disabled in system settings, see page 32.

(4) System LED Indicators - Multiple color indicators will illuminate inside the top cover of the enclosure for visual indication of various system events and/or alarm conditions. See pages 12-26 for detailed information of system events or alarm conditions.

(5) OLED Display Screen - Displays system functions in addition to the visual indication provided by the LED indicators inside the top cover of the enclosure.

(6) Menu Keypad - Toggle between the system functions, program settings, or view all lifetime data stored.

(7) Test/Silence Pushbutton - Used for quick access to lifetime pump run event counter statistic, test or silence the alarm, or exit the menu system. The system MUST be in an idle state (solid green LEDs) to perform testing. When pressed, the event statistic is displayed, then the alarm LEDs will cycle between red, green, blue, and off before TESTING BUZZER is displayed with an audible buzzer sound. During an alarm condition, it will silence the buzzer and the alarm LEDs will continue to flash during an alarm event, see page 27.

(8) Alarm Buzzer - The alarm buzzer will annunciate in addition to the visual indication provided by the LEDs inside the top cover of the enclosure during an alarm condition.

(9) Quick Snap Terminal Blocks - One six-position and a pair of two-position terminal blocks are included to make fast and easy connections for: system power, pump power, alarm or control switches, and filter switch.

(10) Control Relay - Controls current through the pump circuit and is removable, ideal for systems with high usage environments.

(11) Vented Post Cap - Allows airflow to prevent the build up of gases and condensation inside the post.

(12) QR Code (not shown) - Scan code on bottom enclosure cover which directs you to alderonind.com where additional information can be found for the Power Post™.

(13) Cable Grips - Pre-installed, making it easy to run wire in and out of the enclosure. The grips create a liquid and gas tight strain relief connection when securely fastened.

(14) Pump Power Receptacle (not shown) - A female, 15A, pump power receptacle is pre-installed. Available in 120VAC or 240VAC models.

(15) Post - Provides wire routing access for system power, pump power, float switch, and sensor cables while protecting from water intrusion.

Installation

 DISCONNECT ALL POWER SOURCES WHEN INSTALLING OR SERVICING THIS PRODUCT. FAILURE TO TURN OFF ALL POWER SOURCES COULD RESULT IN SERIOUS INJURY OR DEATH.

Installing Post

STEP 1: INSTALL POST

Determine the location for the post in the ground near a tank. Drill access holes for the float switch cables using the customer supplied conduit/fittings or Alderon's riser connection kit (refer to step 2 below).

Run the direct burial power wires underneath the bottom of the post as shown in the illustration to the right.

Note: Seal all conduits to prevent moisture and gases from entering the post per local codes.

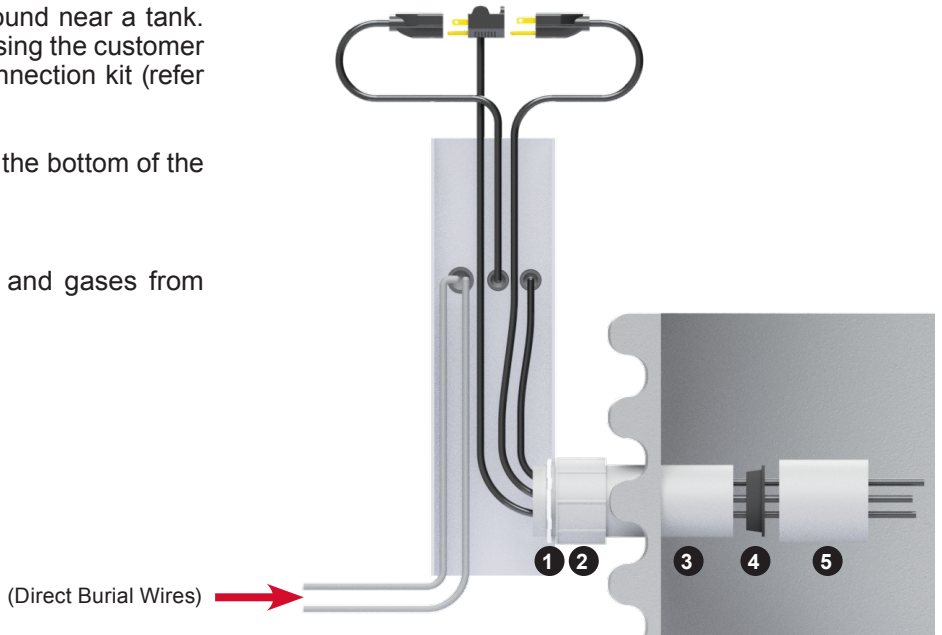

STEP 2: INSTALLING AN ALDERON RISER CONNECTION KIT

1. Determine location for access hole on the post. Drill access hole for the correct size terminal adapter (2.0" or 2.5" depending on model / #2). Insert terminal adapter into access hole. On the inside of the post, use the lock nut (#1) to secure the terminal adapter in place (use PVC cement to ensure proper bonding between the terminal adapter and post per local codes).
2. Insert PVC pipe (conduit / #3) into terminal adapter using appropriate cement for bonding.
3. Determine location on the riser to insert the conduit (2.0" or 2.5" depending on model). If your riser does not have a pre-drilled hole for the conduit, you must drill a hole in the riser to accept the conduit. Insert conduit through the riser hole, which is now attached with the post. Seal conduit to riser hole with silicone or per local codes.
4. Run the pump power, pump float switch, and alarm float switch cables through the PVC coupler (#5). Then continue through the conduit and to the appropriate height inside the post for wiring. Take the 3-hole rubber grommet (#4) which has slits next to the holes and insert cables, then insert the rubber grommet into the conduit.
5. Place the PVC coupler over the end of the conduit.

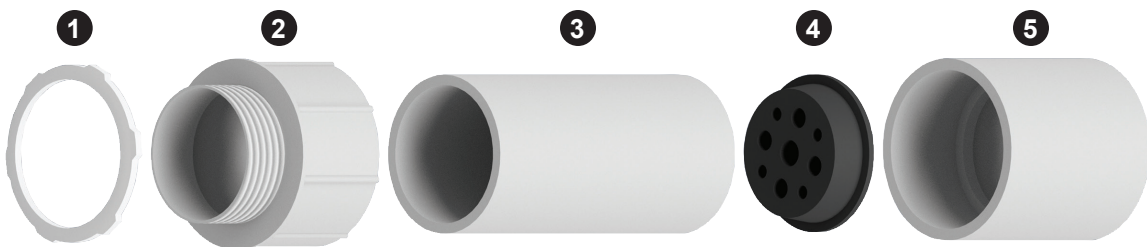

Installing Post (continued)

STEP 3: REMOVE BOTTOM COVER

The bottom enclosure cover is fastened by a single screw on the bottom of the enclosure. Remove the screw and slide the cover directly downward (3A) and then pull directly away from the enclosure (3B).

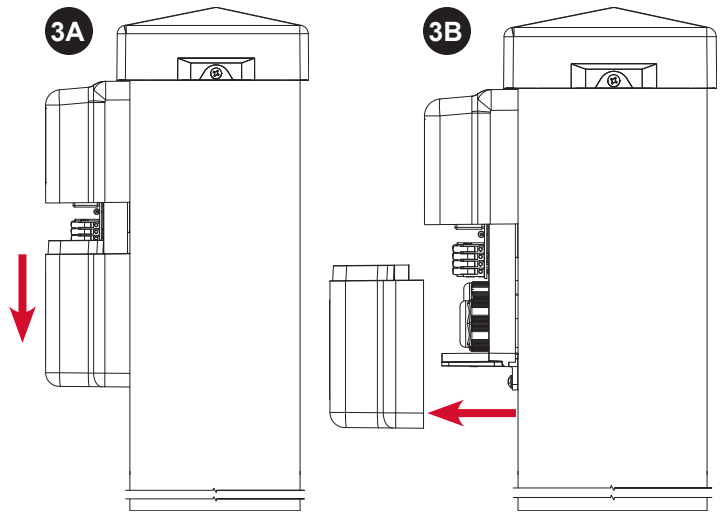

STEP 4: REMOVE POST CAP

Unscrew the fasteners on the left and right of the post cap (4A) and pull directly upwards (4B). Keep the post cap off until installation and testing are completed for wiring access.

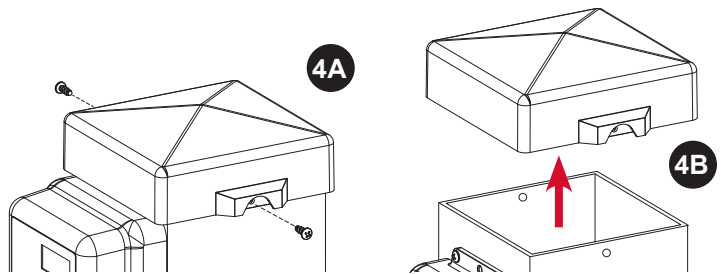

Wiring

INSTALLING WIRE INTO WAGO CONNECTORS

Before making wire connections and terminations, carefully read this section for proper functions of both types of WAGO connectors used with this product.

WARNING: Improper use of the connectors will cause damage to components. DO NOT use mechanical tools to open or close, hand usage only for proper installation and component integrity.

Wire Termination - Splice Connector WAGO (Figure 1):

- 1) Lift tab(s) upward.
- 2) Insert wire(s) into slot.
- 3) Press tab(s) downward.
- 4) Make sure wire(s) are secured.

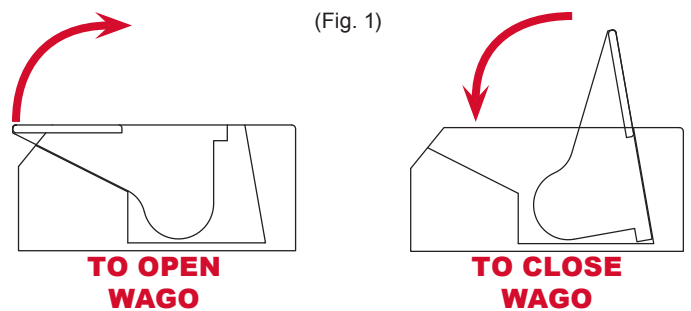

Wire Connection - Quick Snap Terminal WAGO (Figure 2):

- 1) Press tab(s) outward. DO NOT open past a 40° angle to avoid risk of breaking the tab(s).
- 2) Insert wire(s) into slot.
- 3) Press tab(s) inward.
- 4) Make sure wire(s) are secured.

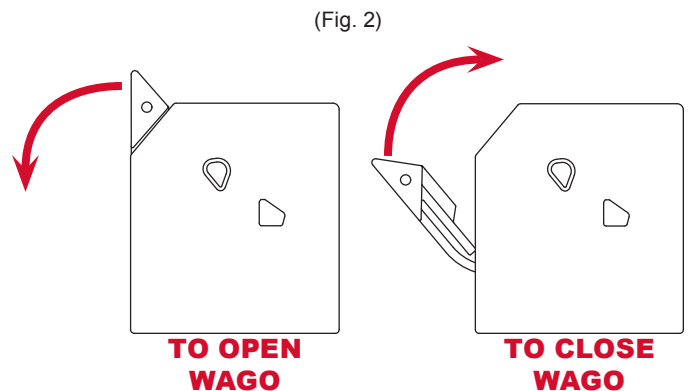

Power Post™ Control Panel - USER GUIDE

Wiring (continued)

STEP 1: WIRING

The wiring diagram shows 10 terminals on the quick snap terminal blocks that consists of five pairs of connections. Make sure to read and review the connector examples on page 7 for proper installation prior to wiring.

Note: The quick snap terminal blocks, are herein referred to as “terminal” for instruction purposes. The installation example shown is for 120VAC, for 240VAC installation the neutral (N) wire would be replaced by line connection (L2) and white wire would include a red band to indicate the wire is hot.

- 1) The first cable grip, starting at the right, has a cable grip divider allowing for two power sources to be brought into the enclosure. The right side of the cable grip is used for the pump power (attached in series). The line wire is connected to terminal 9 and neutral wire is terminated by the two-position Wago connector. The left side of the cable grip is used for the alarm/control power, which is connected to terminals 7 and 8. Terminal 7 is the neutral (N) connection and terminal 8 is the line connection (L1). The pump and alarm/control power ground wires are terminated using the three-position Wago connector. After bringing in the cables, firmly tighten the cable grip by twisting clockwise until securely fastened.
- 2) The female receptacle comes pre-installed in the middle cable grip. The line wire is connected to terminal 10, neutral wire is terminated by the two-position Wago connector, and ground wire is terminated by the three-position Wago connector.
- 3) The third cable grip has cable grip dividers allowing for three sensor connections. The pump control float switch is connected to terminals 1 and 2. The filter switch is connected to terminals 3 and 4. The high level alarm float switch is connected to terminals 5 and 6. After bringing in the cables, firmly tighten the cable grip by twisting clockwise until securely fastened.
- 4) NEVER leave ground wire(s) exposed, use provided Wago connector for wire termination.

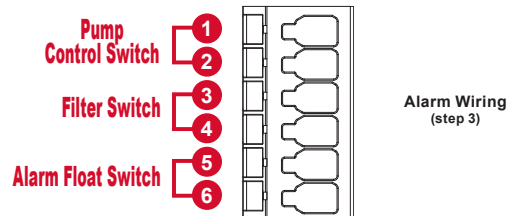
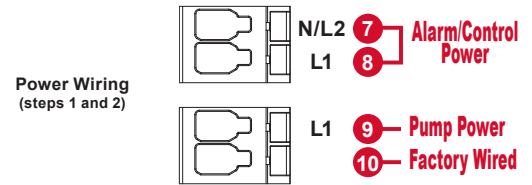
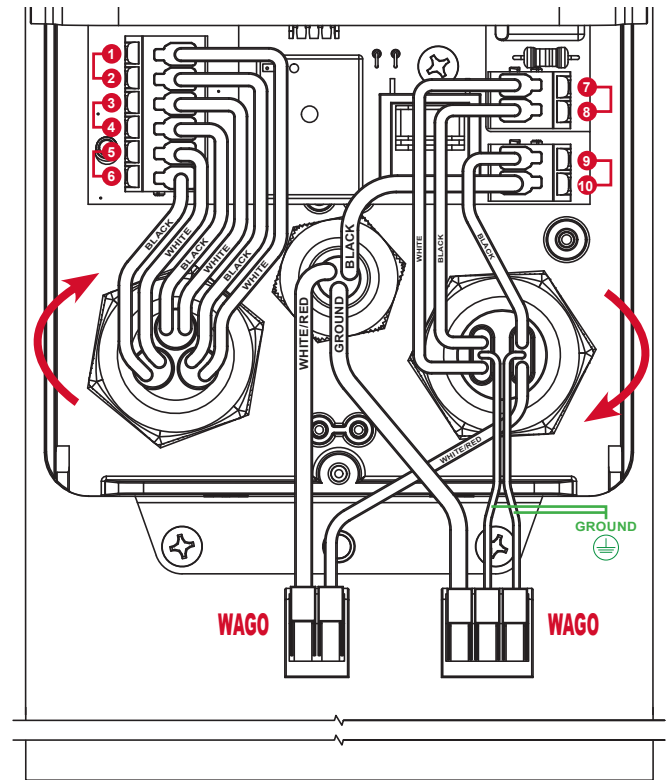

STEP 2: OPTIONAL PIGGYBACK PLUG CONNECTIONS

- 1) Plug the male end of the piggyback plug on the in-line pump switch power cable into the pre-installed female power receptacle inside the post (2A).
- 2) Plug the male end of the pump power cable into the female end of the piggyback plug on the in-line pump switch power cable (2B) from step 2-1.

Note: The installation example shown is for a 120VAC system using an in-line pump switch (optional), use the same process when connecting 240VAC piggyback power cables.

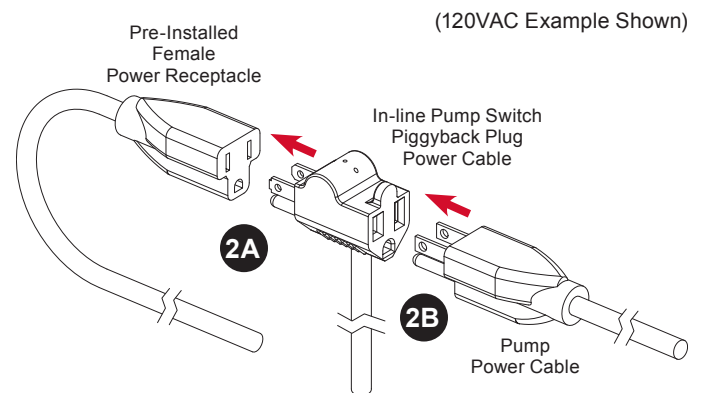

Testing

Make sure all steps of the installation and wiring process is completed and there is power to the product.

STEP 1: TEST ALARM LEDs and BUZZER

Press the test/silence pushbutton on the front of the enclosure, the lifetime pump run event counter statistic should display, then alarm LEDs should illuminate while cycling between red, green, blue, and off. The OLED screen should display a TESTING (COLOR) event to match the respective LEDs after the event statistic is displayed. Last, the buzzer should annunciate and the OLED screen should display a TESTING BUZZER event.

Note: When activated, system test will exit the menu system without saving and disable the menu system. Any events that are active while system test starts will not be shown, but will be tracked normally. Any newly activated event will deactivate the system test event.

STEP 2: TEST ALARM FLOAT SWITCH

The alarm float switch is connected to the sensor terminals (5 and 6). Activate the alarm float switch, the red LEDs should illuminate, flashing and the buzzer should annunciate. The OLED screen should display a HIGH LEVEL ALARM event.

STEP 3: TEST ALARM SILENCE

Press the test/silence pushbutton on the front of the enclosure while the alarm float switch is activated. The red LEDs should keep flashing and the buzzer should silence. The silence condition will reset when the alarm float switch is deactivated.

STEP 4: TEST FILTER SWITCH

The filter switch is connected to the sensor terminals (3 and 4). Activate the filter switch, the amber LEDs should illuminate, flashing and the buzzer should annunciate. The OLED screen should display a FILTER ALARM event.

STEP 5: TEST PUMP AND CONTROL/PUMP FLOAT SWITCH

The pump power is connected to the power terminals (9 and 10) and attached in series, terminated by Wago connectors. Make sure the tank has water to perform the pump and control/in-line pump float switch testing. Activate the pump control float switch or in-line pump float switch (optional), the blue LEDs should illuminate and the OLED screen should display a PUMP RUN event and the pump amps are displayed.

Note: Record the pump amps if changing the high amp level and/or the float type settings in the main menu. See pages 32 and 33 for detailed information.

STEP 6: RECOMMENDED SYSTEM SETTINGS

Alderon™ recommends changing the factory settings for: high amp level, extended pump run time, and gallons per minute. See page 32 for detailed information.

STEP 7: TEST WEEKLY

To ensure the product is functioning properly, test once a week.

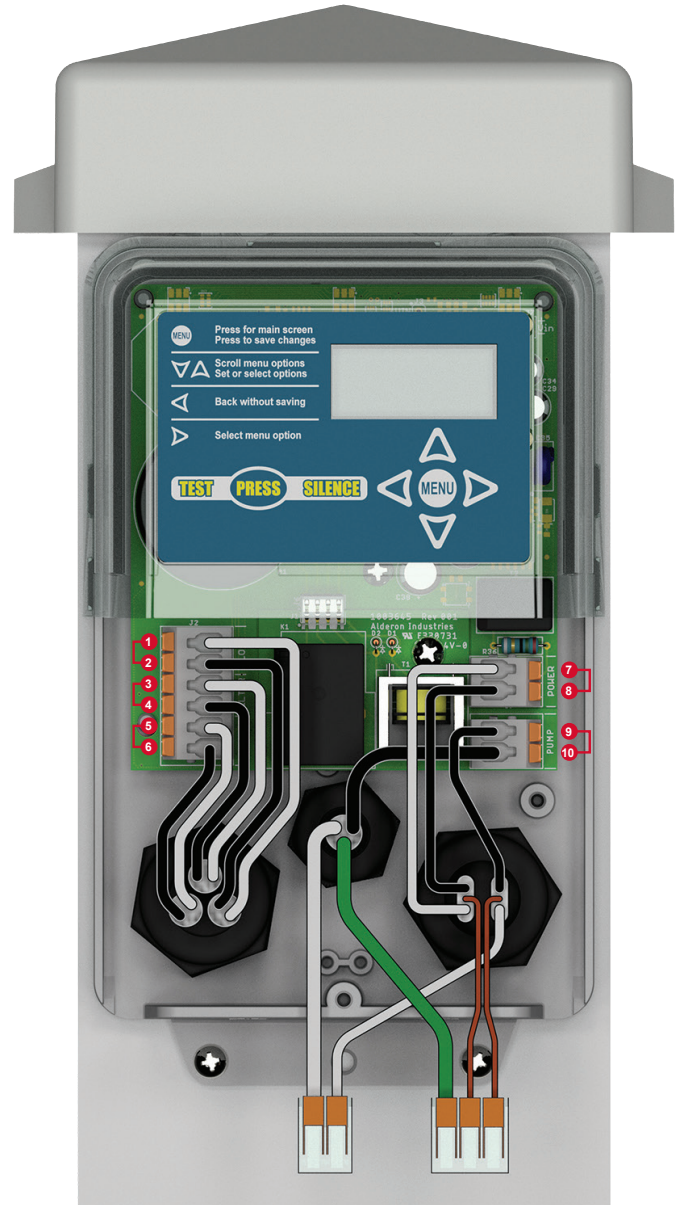

Power Post™ Control Panel - USER GUIDE

Final Installation

STEP 1: INSTALL BOTTOM COVER

Place the bottom of enclosure back on, lining up with the grooves (1A). Then slide the bottom piece directly upward (1B) until it meets the top of the enclosure so the screw hole is lined up. Replace the screw at the bottom of the enclosure.

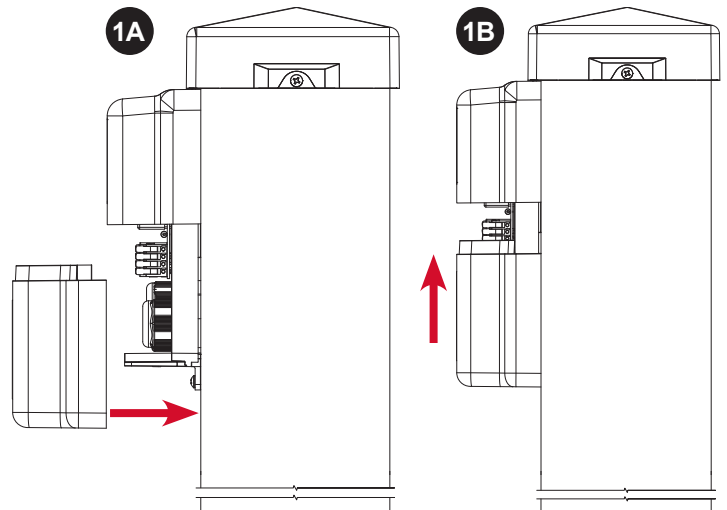

STEP 2: INSTALL POST CAP

To replace the cap, position so the text FRONT (with arrows) on the underneath portion is facing the front of the post and align the fastener holes on the left and right of the cap to the holes on the post (2A). Fasten the screws to properly secure the cap (2B). The cap prevents water intrusion and allows airflow to prevent the build up of gases and condensation inside the post.

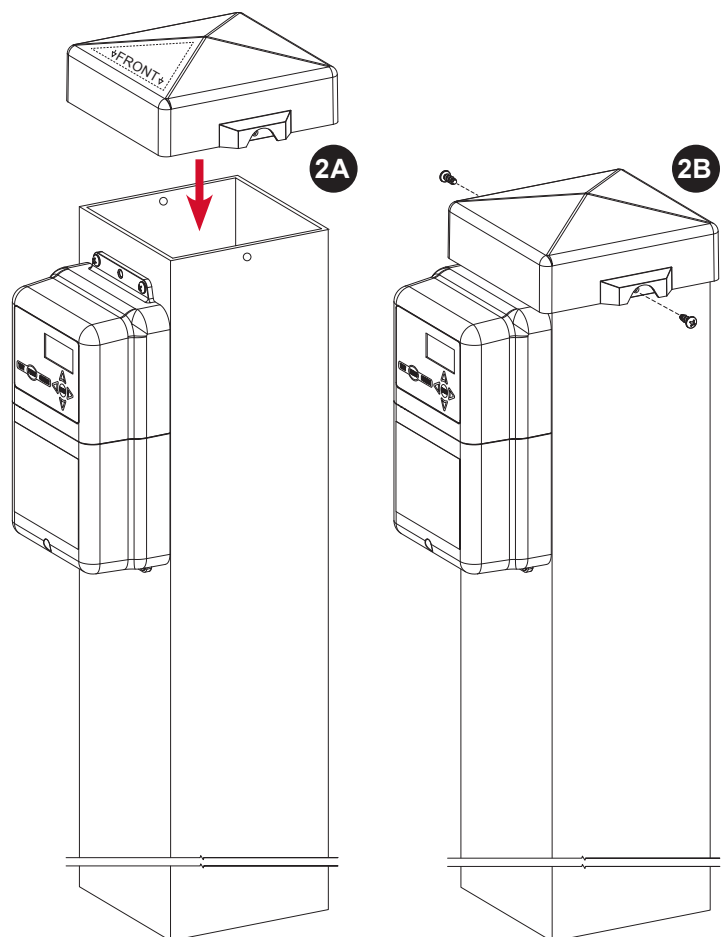

Final Installation (continued)

STEP 3: BACKFILL

Make sure all steps of the installation, wiring, and testing are complete. Take the dirt/soil removed and backfill the area for the post, riser, and direct burial power wiring.

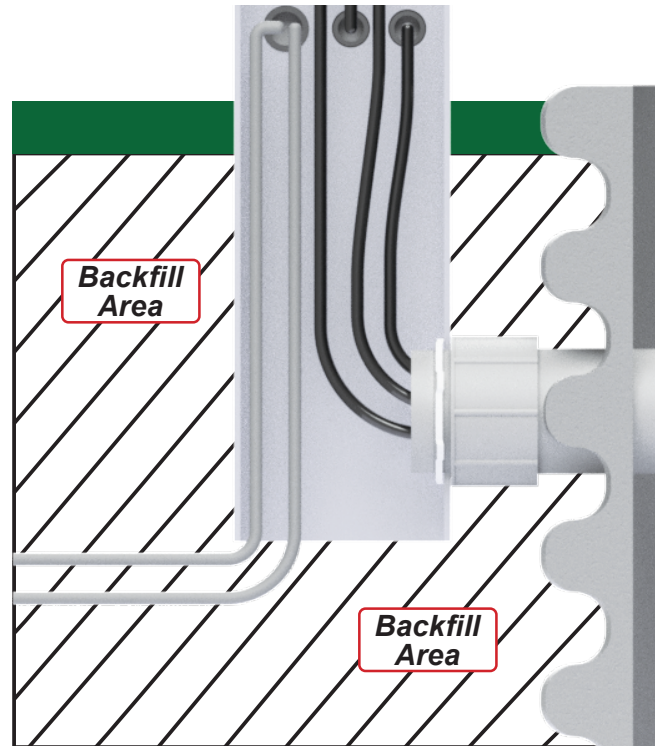

Control Relay Installation

REMOVABLE CONTROL RELAY

The Power Post™ Control Panel comes with a removable control relay, which controls current through the pump circuit and is ideal for systems with high usage environments.

WARNING: Make sure all power sources are disconnected prior to service. Improper removal or installation of the control relay circuit board and 4-position quick connect will cause damage to the pins on the main circuit board. DO NOT use excessive force to ensure component integrity.

Remove Control Relay (Figure 1 and 2):

- 1) Disconnect all power sources.
- 2) Remove power wiring from circuit board terminals (#1).
- 3) Remove the screw (#2).
- 4) Lift control relay circuit board directly upwards (#3).

Replace Control Relay (Figure 1 and 2):

- 1) Align 4-position quick connect between circuit boards (#4).
- 2) Place control relay circuit board onto main board (#3).
- 3) Replace the screw (#2).
- 4) Reconnect power wiring to circuit board terminals (#1).
- 5) Reconnect all power sources and test (page 9).

(Fig. 1)

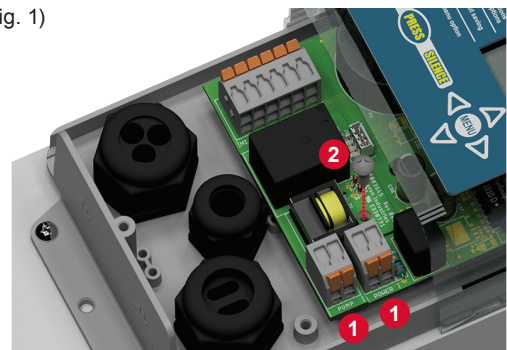

(Fig. 2)

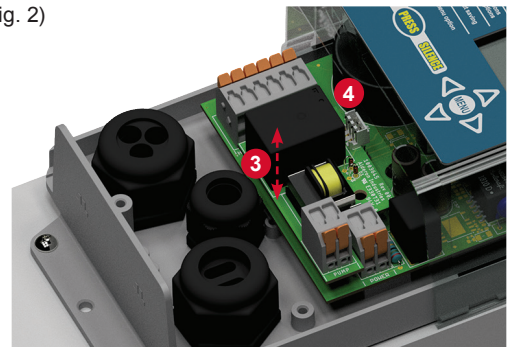

Basic System Functions

The Power Post™ Control Panel includes visual indication provided by the various color LEDs that illuminate inside the top cover of the enclosure along with displayed text on the OLED screen and audible indication provided by the alarm buzzer. This section outlines the basic system functions for: system power, menu access, pump run event, pump alarm events, auxiliary alarm events, timed or demand dosing, peak dosing, and data log center information.

System Power, Menu, and Event Displays

SYSTEM ON AND PUMP OFF

When the system is powered and the pump is off under normal operating conditions, the green LEDs will illuminate inside the top cover of the enclosure to indicate there is power to the system. When the system is idle and there has been no activity or key pressed for approximately 70 seconds, the OLED display screen will be blank.

CAUTION: Before proceeding with the operation of this product, Alderon™ recommends changing factory settings to customize the system per application for desired operation. See pages 31-34 for complete system settings information.

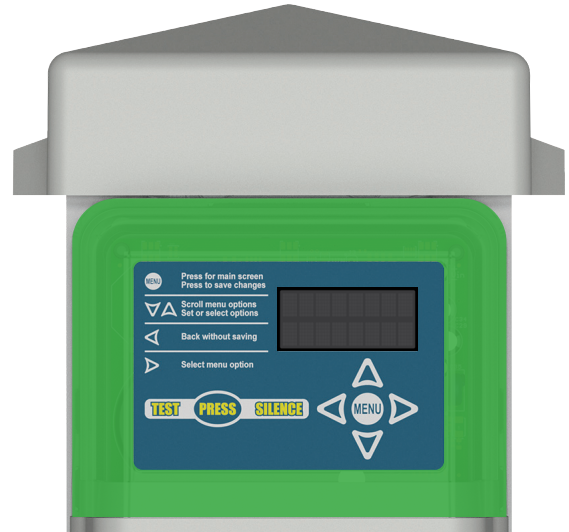

WAKE SYSTEM

To wake the OLED display screen, press any arrow key (up, down, left, or right) on the menu keypad and SYSTEM NORMAL will appear (Figure 1). Turn off the green power on LEDs in the settings menu, see page 32 for detailed information.

SYSTEM MENU

To access the system menu, press MENU on the menu keypad and HAND/OFF AUTO will appear (Figure 2). Pressing the MENU button from a blank screen will also access the main menu. To view the list of menu screens and system settings, see pages 28-36 for detailed information.

(Fig. 1)

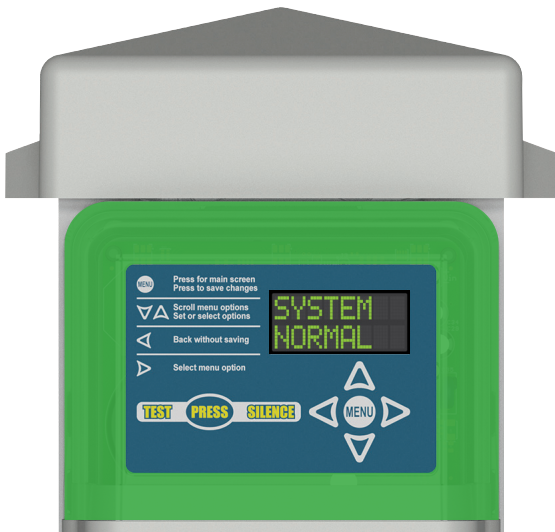

(Fig. 2)



Hand-Off-Auto and System Override

HAND-OFF-AUTO

The system includes a hand-off-auto pump selector option to switch the pump mode to off, factory set to automatic mode. Press the right arrow key from the hand-off-auto screen to access **VERRIDE SYSTEM?**, press **MENU** to accept the question and activate a system override event. See pages 25 and 29 for detailed information and display screens.

- **Override System?** - Press **MENU** to accept question and switch the pump mode to off.
- **Hold to Run Pump?** - Press and hold the **MENU** button for manual operation of the pump. The pump will continue to run as long as the **MENU** button is pressed.
- **System Auto?** - Press **MENU** to accept question and switch the pump mode to automatic.



Timed or Demand Dosing

In the settings menu, use the menu keypad to configure the system for either timed or demand dosing. The factory setting is timed dosing and **DEMAND DOSE?** will appear (Figure 3). Pressing the **MENU** button will accept the question, switching the system to demand dosing. When the system is programmed to demand dosing, **TIMED DOSE?** will appear (Figure 4). Pressing the **MENU** button will accept the question, switching the system to timed dosing. See page 33 for system settings.

Demand Dosing - The system operates based on liquid level demand using control and/or pump switches to operate the pump for each pump cycle.

Timed Dosing - The system operates based on the programmed time settings using control and/or pump switches to operate the pump for specified time intervals which controls the on and off time of each pump cycle.

(Fig. 3)



(Fig. 4)

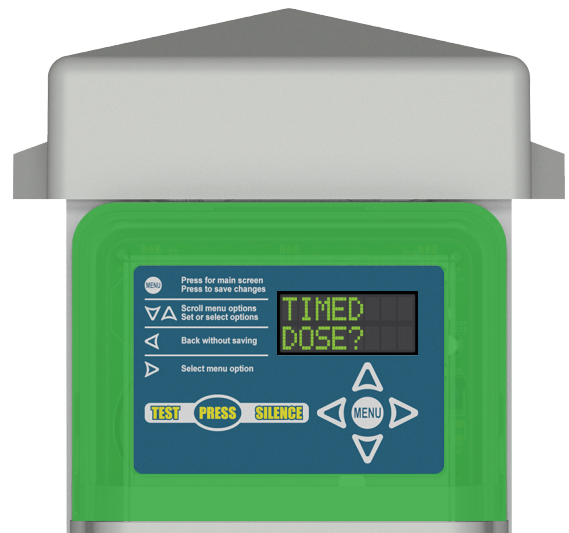

Power Post™ Control Panel - USER GUIDE

Pump Run and Total Gallons Pumped

PUMP RUN

When the pump is running under normal operating conditions in either timed or demand dosing mode, the blue LEDs will illuminate inside the top cover of the enclosure. The OLED screen will display a PUMP RUN event and the pump amps are displayed. Use the menu keypad to access the pump run information below while the pump is running or when the system is idle. Turn off the blue pump run LEDs in the settings menu. See pages 32, 37, and 48 for detailed information and display screens.

- **Pump Run Event Counter** - Records each pump event.
- **Pump Run Elapsed Time** - Records the total run time of each pump run event including: last, average, maximum, and minimum of the last 10 pump cycles.
- **Pump Amp Detection** - Records the amps each time a pump event occurs including: last, average, maximum, and minimum of the last 10 pump cycles.
- **Pump Float Event Counter** - Records each time the pump float is activated during a pump run event.
- **Pump Run Settings** - Use the menu keypad to change the factory settings for: pump run LED turn on or off and gallons per minute. See page 32 for detailed information.
- **All Data Stored in Two Formats**
 - i. Resettable; Reset all data to zero.
 - ii. Non-Resettable; All lifetime data is stored.



PUMP RUN - TOTAL GALLONS PUMPED (TGP)

When the pump is running under normal operating conditions in either timed or demand dosing mode, the system will record total gallons pumped. This calculation is based on the gallons per minute (GPM) setting, factory set to zero. Use the menu keypad to access the information below while the pump is running or when the system is idle. See pages 32, 37, 38, 48, and 49 for detailed information and display screens.

- **TGP Stats** - Records total gallons pumped. When the maximum displayed gallons are exceeded, the gallons will restart at zero (maximum value of 9999999G).
- **GPM Setting** - Use the menu keypad to change the setting. If the GPM is set to zero, the TGP stats will not be displayed on the OLED screen. See page 32 for detailed information.
- **Manually Calculate GPM Value to Program**
 - i. Measure water level in tank.
 - ii. Run pump for designated amount of time.
 - iii. Measure new water level in tank.
 - iv. Calculate results from test.
- **All Data Stored in Two Formats**
 - i. Resettable; Reset all data to zero.
 - ii. Non-Resettable; All lifetime data is stored.



Pump Alarms

EXTENDED PUMP RUN ALARM

An extended pump run alarm event will occur when the pump has run continuously for longer than the configured amount of time, factory set to 30 minutes. This event occurs if the system is programmed to either timed or demand dosing.

The red and blue LEDs will illuminate inside the top cover of the enclosure and alternate every second. The alarm buzzer will announce and OLED screen will display an EXT PUMP ALARM event. Press the test/silence pushbutton to silence the buzzer during an alarm event, factory set to 24 hours. The alarm condition will clear once the system no longer detects an extended pump run event.

Use the menu keypad to access the extended pump run alarm information below while the pump is running or when the system is idle. See pages 32, 38, and 49 for detailed information and display screens.

- **Extended Pump Run Event Counter** - Records each extended pump run event.
- **Extended Pump Run Elapsed Time** - Records the total run time of each extended pump run event including: last, average, maximum, and minimum of the last 10 extended pump run cycles.
- **Extended Pump Run Amp Detection** - Records the amps each time an extended pump run event occurs including: last, average, maximum, and minimum of the last 10 pump cycles.
- **Extended Pump Run Setting** - Use the menu keypad to change the factory setting of 30 minutes. See page 32 for detailed information.
- **Extended Gallons Per Minute (GPM) Setting** - Factory set to zero, use the menu keypad to change the setting. If the GPM is set to zero, the total gallons pumped stats will not be displayed on the OLED screen.
- **Silence Time Setting** - Use the menu keypad to change the factory setting for alarm event silence time, factory set to 24 hours. See page 32 for detailed information.
- **All Data Stored in Two Formats**
 - i. Resettable; Reset all data to zero.
 - ii. Non-Resettable; All lifetime data is stored.



« « « Alternating LEDs » » »



Power Post™ Control Panel - USER GUIDE

Pump Alarms (continued)

HIGH AMP ALARM

A high amp alarm event will occur when the current sensed on the pump input during a pump run event is equal to or greater than the configured high amp threshold setting, factory set to 15 Amps. This event occurs if the system is programmed to either timed or demand dosing.

The high amp alarm will not be activated during the initial startup of a pump run event, even if the high amp threshold is exceeded to account for high amp draw during pump startup. The high amp threshold is deactivated as soon as the current sensed on the pump is less than the programmed setting.

The purple and blue LEDs will illuminate inside the top cover of the enclosure and alternate every second. The alarm buzzer will announce and OLED screen will display a HIGH AMP ALARM event. Press the test/silence pushbutton to silence the buzzer during an alarm event, factory set to 24 hours. The alarm condition will clear once the system no longer detects a high amp event.

Use the menu keypad to access the high amp alarm information below while the pump is running or when the system is idle. See pages 32, 39, and 50 for detailed information and display screens.

- **High Amp Event Counter** - Records each high amp event.
- **High Amp Elapsed Time** - Records the total run time of each high amp event including: last, average, maximum, and minimum of the last 10 extended pump run cycles.
- **High Amp, Amp Detection** - Records the amps each time a high amp event occurs including: last, average, maximum, and minimum of the last 10 pump cycles.
- **High Amp Setting** - Use the menu keypad to change the high amp factory setting of 15 Amps. See page 32 for detailed information.
- **Silence Time Setting** - Use the menu keypad to change the factory setting for alarm event silence time, factory set to 24 hours. See page 32 for detailed information.
- **All Data Stored in Two Formats**
 - i. Resettable; Reset all data to zero.
 - ii. Non-Resettable; All lifetime data is stored.



« « Alternating LEDs » »



Timed Dose On and Timed Dose Off

TIMED DOSE ON

When the system is programmed to timed dosing and the pump is running under normal operating conditions during a timed dose, the blue LEDs will illuminate inside the top cover of the enclosure. The OLED screen display will alternate between DOSE ON and PUMP RUN events, the current dose on setting will appear on the screen, factory set to 5 seconds.

The pump will continue to run until the time counts down to zero, then switches to a DOSE OFF event based on the system dose end setting. The factory setting is STOP DOSE, which turns the pump off when the pump control float switch is deactivated or choose FINISH DOSE to turn the pump off when the dose on time setting reaches zero.

Use the menu keypad to access the dose on information below while the pump is running or when the system is idle. Turn off the blue pump run LEDs in the settings menu. See pages 33, 41, and 51 for detailed information and display screens.



- **Dose On Event Counter** - Records each pump event.
- **Dose On Elapsed Time** - Records the total run time of each dose on event including: last, average, maximum, and minimum of the last 10 pump cycles.
- **Dose On Time Setting** - Use the menu keypad to change the factory setting of 5 seconds. See page 33 for detailed information.
- **Dose End Setting** - Choose how to end the pump cycle when the system is in timed dosing mode. See page 34 for detailed information.
- **All Data Stored in Two Formats**
 - i. Resettable; Reset all data to zero.
 - ii. Non-Resettable; All lifetime data is stored.

TIMED DOSE OFF

When the system is programmed to timed dosing and the pump is off under normal operating conditions during a timed dose, the green LEDs will illuminate inside the top cover of the enclosure. The OLED screen will display a DOSE OFF event, the current setting will appear on the screen, factory set to 10 seconds. There are no statistics for a timed dose off event.

The pump will remain off until the programmed time counts down to zero, then the system will activate a DOSE ON event for the programmed amount of time. See page 33 for detailed information and display screens.

- **Dose Off Time Setting** - Use the menu keypad to change the factory setting of 10 seconds. See page 33 for detailed information.



Power Post™ Control Panel - USER GUIDE

Peak Dose On

PEAK DOSE ON

When the system is programmed to timed dosing and the high level alarm float switch is activated during a dose on event, the system will activate a PEAK ON event. The LEDs will illuminate inside the top cover of the enclosure, alternating between blue (solid) and red (flashing). The OLED screen display will alternate between PEAK ON and HIGH LVL ALARM events. The current peak on setting will appear on the screen, factory set to 5 seconds.

The peak on event indicates peak system demand during a timed dosing event. The pump will continue to run until the time counts down to zero, then switches to a PEAK OFF event based on the system dose end setting. The factory setting is STOP DOSE, which turns the pump off when both the high level alarm and pump control float switches are deactivated or choose FINISH DOSE to turn the pump off when the peak on time setting reaches zero. See pages 19 and 33 for the system setting of minimum peak dose cycles, which is the total amount of peak on doses that will occur during peak demand.

Use the menu keypad to access the peak on information below while the pump is running or when the system is idle. Turn off the blue pump run LEDs in the settings menu. See pages 32, 42, and 52 for detailed information and display screens.

- **Peak On Event Counter** - Records each pump event.
- **Peak On Elapsed Time** - Records the total run time of each dose on event including: last, average, maximum, and minimum of the last 10 pump cycles.
- **Peak On Time Setting** - Use the menu keypad to change the factory setting of 5 seconds. See page 33 for detailed information.
- **Dose End Setting** - Choose how to end the pump cycle when the system is in timed dosing mode. See page 34 for detailed information.
- **Buzzer Delay Setting** - Choose how long to delay the activation of the alarm buzzer when the system is in timed dosing mode and a high level alarm event occurs. See page 34 for detailed information.
- **All Data Stored in Two Formats**
 - i. Resettable; Reset all data to zero.
 - ii. Non-Resettable; All lifetime data is stored.



« « Alternating Event Displays and LEDs » »



Peak Dose Off and Minimum Peak Doses

PEAK DOSE OFF - HIGH LEVEL ALARM ACTIVATED

When the system is programmed to timed dosing and the pump is off during a peak on event while the high level alarm float switch is still activated, the red LEDs will illuminate (flashing) inside the top cover of the enclosure. The OLED screen display will alternate between PEAK OFF and HIGH LVL ALARM events. The current dose off setting will appear on the screen, factory set to 10 seconds. There are no statistics for a peak dose off event, however, the high level alarm statistics will be stored.

The pump will remain off until the programmed time counts down to zero, then the system will activate a DOSE ON or PEAK ON event. The high level alarm event remains activated until the high level alarm float switch is deactivated. See pages 17, 18, and 33 for detailed information and display screens.



PEAK DOSE OFF - PUMP CONTROL FLOAT DEACTIVATED

When the system is programmed to timed dosing and the pump is off during a peak on event while the high level alarm float switch is deactivated, the green LEDs will illuminate inside the top cover of the enclosure. The OLED screen will display a PEAK OFF event, the current dose off setting will appear on the screen, factory set to 10 seconds. There are no statistics for a peak dose off event.

The pump will remain off until the programmed time counts down to zero, then the system will activate a DOSE ON or PEAK ON event. See pages 17, 18, and 33 for detailed information and display screens.



- **Peak Off Time Setting** - Use the menu keypad to change the factory setting of 10 seconds. See page 33 for detailed information.
- **Buzzer Delay Setting** - Choose how long to delay the activation of the alarm buzzer when the system is in timed dosing mode and a high level alarm event occurs. See page 34 for detailed information.

MINIMUM PEAK DOSE CYCLES - SETTING

When the system is programmed to timed dosing and peak dose on and off time settings have been programmed, the minimum amount of peak dose cycles should also be programmed. The minimum peak doses is factory set to 1, the allowable range is a numeric value between 1 and 9. See page 33 for detailed information and display screens.

- **Minimum Peak Doses Setting** - Use the menu keypad to change the factory setting of 1 dose. See page 33 for detailed information.

Note: After the pump control float switch is deactivated, the system will resume normal timed dose settings even if the programmed minimum peak dose cycles have not occurred.



Power Post™ Control Panel - USER GUIDE

Auxiliary Alarms

HIGH LEVEL ALARM

When the high level alarm float switch is activated, the red LEDs will illuminate (flashing) inside the top cover of the enclosure. The alarm buzzer will annunciate and OLED screen will display a HIGH LVL ALARM event. Press the test/silence pushbutton to silence the buzzer during an alarm event, factory set to 24 hours. The alarm condition will clear once the alarm float switch is deactivated. This event occurs if the system is programmed to either timed or demand dosing.

Use the menu keypad to access the high level alarm information below during an active event or when the system is idle. See pages 32, 43, and 53 for detailed information and display screens.

- **High Level Alarm Event Counter** - Records each high level event.
- **High Level Alarm Elapsed Time** - Records the total run time of each high level event including: last, average, maximum, and minimum of the last 10 events.
- **Silence Time Setting** - Use the menu keypad to change the factory setting for alarm event silence time, factory set to 24 hours. See page 32 for detailed information.
- **All Data Stored in Two Formats**
 - i. Resettable; Reset all data to zero.
 - ii. Non-Resettable; All lifetime data is stored.



FILTER ALARM

When the filter switch alarm is activated, the amber LEDs will illuminate (flashing) inside the top cover of the enclosure. The alarm buzzer will annunciate and OLED screen will display a FILTER ALARM event. Press the test/silence pushbutton to silence the buzzer during an alarm event, factory set to 24 hours. The alarm condition will clear once the effluent filter has been cleaned and the filter switch is deactivated. This event occurs if the system is programmed to either timed or demand dosing.

Use the menu keypad to access the filter alarm information below during an active event or when the system is idle. See pages 32, 44, and 54 for detailed information and display screens.

- **Filter Alarm Event Counter** - Records each filter alarm event.
- **Filter Alarm Elapsed Time** - Records the total run time of each filter alarm event including: last, average, maximum, and minimum of the last 10 events.
- **Silence Time Setting** - Use the menu keypad to change the factory setting for alarm event silence time, factory set to 24 hours. See page 32 for detailed information.
- **All Data Stored in Two Formats**
 - i. Resettable; Reset all data to zero.
 - ii. Non-Resettable; All lifetime data is stored.



Auxiliary Alarms (continued)

PUMP FAILURE ALARM

When a pump failure alarm event is activated, the purple LEDs will illuminate (flashing) inside the top cover of the enclosure. The alarm buzzer will annunciate and OLED screen will display a PUMP FAILURE event. Press the test/silence pushbutton to silence the buzzer during an alarm event, factory set to 24 hours. The alarm condition will clear once the pump failure alarm is cleared through the menu system. This event occurs if the system is programmed to either timed or demand dosing.

Timed Dose (Dose On or Peak On):

- Pump is expected to run but no current is detected.

Demand Dose:

- Float Input Selected: Control float input is activated and no current is detected.
- In-line Float Selected: High level float is activated and no current is detected.

Use the menu keypad to access the pump failure alarm information below during an active event or when the system is idle. See pages 32, 45, and 55 for detailed information and display screens.

- **Pump Failure Alarm Event Counter** - Records each pump failure event.
- **Pump Failure Alarm Elapsed Time** - Records the total run time of each pump failure event including: last, average, maximum, and minimum of the last 10 events.
- **Silence Time Setting** - Use the menu keypad to change the factory setting for alarm event silence time, factory set to 24 hours. See page 32 for detailed information.
- **All Data Stored in Two Formats**
 - Resettable; Reset all data to zero.
 - Non-Resettable; All lifetime data is stored.



POWER LOSS ALARM

When the internal AC power supply is lost, the system conserves power until the statistics have been saved before a power loss alarm event is activated. The alarm buzzer will annunciate a quick bleep and no LEDs are illuminated inside the top cover of the enclosure. The OLED screen will display a PWR LOSS ALARM event before the screen goes blank. This event occurs if the system is programmed to either timed or demand dosing.

Use the menu keypad to access the power loss alarm information below after the system has been restored and is idle. See pages 47 and 57 for detailed information and display screens.

- **Power Loss Alarm Event Counter** - Records each power loss event.
- **All Data Stored in Two Formats**
 - Resettable; Reset all data to zero.
 - Non-Resettable; All lifetime data is stored.



Power Post™ Control Panel - USER GUIDE

System Alarms

RELAY FAILURE ALARM

When a relay failure alarm event is activated, the red and blue LEDs will illuminate inside the top cover of the enclosure and alternate every second. The alarm buzzer will annunciate and OLED screen will display a RELAY FAILURE event. Press the test/silence pushbutton to silence the buzzer during an alarm event, factory set to 24 hours. The alarm condition will clear once the relay has been replaced and the relay failure alarm is cleared through the menu system. This event occurs if the system is programmed to either timed or demand dosing.

A relay failure alarm occurs when the pump is expected to be off but current is detected, which is caused by a relay contact being stuck in a closed state. The red and blue LEDs will alternate three times with RELAY FAILURE displayed on the screen, then the LEDs switch to solid blue with PUMP RUN displayed on the screen.

The system will cycle between relay failure and pump run events while in demand dosing mode. If the system is in timed dosing mode, the LEDs switch from solid blue (pump run) to solid green with the current DOSE OFF setting displayed on the screen. The system will cycle through relay failure, pump run, and dose off displayed events with their respective LED indicators.

Use the menu keypad to access the relay failure alarm information below during an active event or when the system is idle. See pages 32, 46, and 56 for detailed information and display screens.

- **Relay Failure Alarm Event Counter** - Records each system failure event.
- **Relay Failure Alarm Elapsed Time** - Records the total run time of each system failure event including: last, average, maximum, and minimum of the last 10 events.
- **Silence Time Setting** - Use the menu keypad to change the factory setting for alarm event silence time, factory set to 24 hours. See page 32 for detailed information.
- **All Data Stored in Two Formats**
 - i. Resettable; Reset all data to zero.
 - ii. Non-Resettable; All lifetime data is stored.



« « « Alternating LEDs » » »



System Alarms (continued)

SYSTEM FAILURE ALARM

A system failure event is available only when the system is programmed to demand dosing. When a system failure alarm event is activated, the red LEDs will illuminate (flashing) inside the top cover of the enclosure. The alarm buzzer will annunciate, OLED screen will display a SYSTEM FAILURE event, and power to the pump will be turned off. Press the test/silence pushbutton to silence the buzzer during an alarm event, factory set to 24 hours. The alarm condition will clear once the system failure alarm is cleared through the menu system.

A system failure alarm occurs when an extended pump run event has been active for either 20 minutes or the length of the extended pump run time setting, whichever is greater. If the high level alarm float switch is activated and/or deactivated during a system failure event, power is reapplied to the pump and will run for the duration of the programmed extended pump run time. Check floats to see if they are stuck in a closed state, see below for two event examples.

Use the menu keypad to access the system failure alarm information below during an active event or when the system is idle. See pages 32, 47, and 57 for detailed information and display screens.



- **System Failure Alarm Event Counter** - Records each system failure event.
- **System Failure Alarm Elapsed Time** - Records the total run time of each system failure event including: last, average, maximum, and minimum of the last 10 events.
- **Silence Time Setting** - Use the menu keypad to change the factory setting for alarm event silence time, factory set to 24 hours. See page 32 for detailed information.
- **All Data Stored in Two Formats**
 - i. Resettable; Reset all data to zero.
 - ii. Non-Resettable; All lifetime data is stored.

Event Example 1 (after system failure event is activated):

- 1) High Level Alarm Float Switch is activated or deactivated while power to the pump is turned off.
- 2) Pump power is applied, PUMP RUN event occurs and the alarm buzzer annunciates.
- 3) Event display changes from PUMP RUN to alternating between HIGH LVL ALARM and SYSTEM FAILURE.
- 4) LEDs change from solid blue (pump run) to flashing red (high level alarm).
- 5) Pump runs for duration of extended pump run time setting while the system cycles between the system events with respective LED indicators and then power to the pump is turned off.
- 6) After system maintenance determines system is okay, press MENU while SYSTEM FAILURE is displayed on the screen and CLEAR SYS FAIL? will appear. Press MENU for CHECKING SYS FAIL, and system will return to SYSTEM NORMAL for normal operation.

Event Example 2 (after system failure event is activated):

- 1) High Level Alarm Float Switch is activated and the Pump Control Float Switch is deactivated while power to the pump is turned off.
- 2) Pump power is applied, PUMP RUN event occurs and the alarm buzzer annunciates.
- 3) Event display changes from PUMP RUN to HIGH LVL ALARM, then FLOAT FAILURE, and then SYSTEM FAILURE.
- 4) LEDs change from solid blue (pump run) to flashing red (high level alarm), then white/cyan alternating (float failure), and then back to flashing red (system failure).
- 5) Pump runs for duration of extended pump run time setting while the system cycles between the system events with respective LED indicators and then power to the pump is turned off.
- 6) After system maintenance determines system is okay, press MENU while SYSTEM FAILURE is displayed on the screen and CLEAR SYS FAIL? will appear. Press MENU for CHECKING SYS FAIL, and system will return to SYSTEM NORMAL for normal operation.

System Alarms (continued)

FLOAT FAILURE

When the high level alarm float switch is activated and the pump control float switch is deactivated, the white and cyan LEDs will illuminate inside the top cover of the enclosure and alternate every second. The alarm buzzer will annunciate and OLED screen will display a FLOAT FAILURE event. Press the test/silence pushbutton to silence the buzzer during an alarm event, factory set to 24 hours. The event condition will clear when the pump control float switch is activated or the high level alarm float switch is deactivated and the float fail event is cleared through the menu system. There are no statistics for this event. This event occurs if the system is programmed to either timed or demand dosing.

A float failure event indicates a contact inside the pump control float switch is stuck in an open state, the float switches were not wired properly, or an obstruction is preventing the normal operation of the pump control float switch. See pages 8, 9, 63, and 64 for detailed wiring and troubleshooting information.

- **Silence Time Setting** - Use the menu keypad to change the factory setting for alarm event silence time, factory set to 24 hours. See page 32 for detailed information.



« « Alternating LEDs » »



System Override Event

SYSTEM OVERRIDE

From the hand-off-auto pump selector screen in the main menu, press the right arrow key to access **OVERRIDE SYSTEM?**, and then press **MENU** to accept the question which activates a system override event. If the current state of the system is in normal operating conditions (Figure 5), the green LEDs (solid) will change to white (flashing) inside the top cover of the enclosure and **HOLD TO RUN PMP?** (Figure 6) will appear on the screen. There is no alarm buzzer or statistics for this event. Use the down arrow key to toggle between the menu options, see page 29 for detailed information.

- **Override System?** - Press **MENU** to accept question and switch the pump mode to off, **HOLD TO RUN PMP?** (Figure 6) will appear on the screen and white LEDs (flashing) will illuminate inside the top cover of the enclosure. See below for manual operation of the pump or use the down arrow key to the next menu option.
- **Hold to Run Pump?** - Press and hold the **MENU** button for manual operation of the pump when **HOLD TO RUN PMP?** (Figure 6) is displayed on the screen. The pump will continue to run as long as the **MENU** button is pressed. The pump run and pump fail events with respective LED indicators will be activated as normal. From this screen, use the down arrow key to the next menu option.
- **System Auto?** - Press **MENU** to accept question when **SYSTEM AUTO?** (Figure 7) appears on the screen to switch the pump mode to automatic. The system will display **SYSTEM NORMAL** (Figure 8) on the screen and the white LEDs (flashing) will change back to green (solid) if the system is in normal operating conditions.

(Fig. 5)



(Fig. 6)



(Fig. 7)



(Fig. 8)



Power Post™ Control Panel - USER GUIDE

System Functions | Events, Statistics, Settings, and Menu

The Power Post™ Control Panel includes visual indication provided by the various color LEDs that illuminate inside the top cover of the enclosure along with displayed text on the OLED screen and audible indication provided by the alarm buzzer. This section outlines system function screen displays for: system normal, main menu, resettable and lifetime history data log center, settings, system events, and model name with firmware version.

Basic System Functions and Event Displays

The basic system functions with displayed text and corresponding LED indicator colors for system events are listed below. Refer to the value charts for additional system displays of statistical data and descriptions for each.

Power Post™ Control Panel Timed or Demand Dose - System Functions and Event Displays		
ENCLOSURE LED INDICATOR	SYSTEM FUNCTION DISPLAYED TEXT	DESCRIPTION OF SYSTEM FUNCTION
Green Continuous	SYSTEM NORMAL	System is Normal
Blue Continuous	PUMP RUN or DOSE ON	Pump is Running Normal during Pump Run, Normal Dose On, and Peak Dose On Events
Red/Blue Alternating	EXT PUMP ALARM	Alarm - Pump is Running Continuously; Check Pump Float or Broken Pipe
Purple/Blue Alternating	HIGH AMP ALARM	Alarm - Pump is Drawing High Amps; Check Pump and Pump Blockages
Purple Flashing	PUMP FAILURE	Alarm - Pump is NOT Drawing Amps; Check Pump Float and Pump, Press Menu to Clear Fault
Purple/Red Alternating	PUMP FAILURE/HIGH LVL ALARM	Pump is NOT Drawing Amps/Tank is Full; Check Pump Float and Pump, Press Menu to Clear Fault
Red Flashing	HIGH LVL ALARM	Tank is at High Level; Check Pump Float and Pump
Amber Flashing	FILTER ALARM	Filter needs Cleaning; Check Effluent Filter
White/Cyan Alternating	FLOAT FAILURE	Pump Control Float is NOT Activated, High Level Float is Activated; Check Float Switches
Red Flashing	SYSTEM FAILURE	Extended Pump Run Event is Active for 20 Minutes or Length of Time Setting (whichever is greater)
White/Cyan Alternating	UI ERROR (event not displayed)	Faceplate or OLED Screen Not Connected to Circuit Board; Check Ribbon for Proper Connection

Statistic Value Displays

The charts in this section show how the statistical data is displayed on the OLED screen for amps and elapsed time meter.

Amp Statistic	Statistic Prefix
Last	AMP
Average	AvA
Maximum	MxA
Minimum	MnA

Amp Value Format	Description
---.	No amp data
xx.x	Amps to nearest 0.1A
> 20	Amps exceed maximum detectable current

Elapsed Time Statistic	Statistic Format (seconds)	Statistic Format (minutes)	Statistic Format (hours)	Statistic Format (out of range)
Last	SEC xxx	MIN xxx	HRS xxx	HRS >999
Average	AvgS xxx	AvgM xxx	AvgH xxx	AvgH >999
Maximum	MaxS xxx	MaxM xxx	MaxH xxx	MaxH >999
Minimum	MinS xxx	MinM xxx	MinH xxx	MinH >999

Note: The statistic format for elapsed time will display in seconds and minutes up to 599 for each, hours will display up to 999, and hour values greater than 999 will display “out of range” (>999).

Product Label Examples

MENU LEGEND and KEYPAD

The menu legend and keypad are located on the product label, see the examples to the right and detailed text version below.

- 1) Press the MENU button to access the main menu screen, accept settings questions, or save changes.
- 2) Press the DOWN or UP arrows to scroll through the list of menu options and to set or select system options.
- 3) Press the LEFT arrow to go back without saving from any menu or settings option screen.
- 4) Press the RIGHT arrow to select menu options or to enter the next value in the settings option screens.

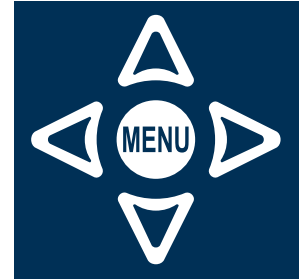
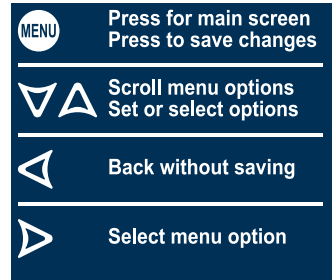

TEST / SILENCE PUSHBUTTON

The test/silence pushbutton is used for quick access to lifetime pump run event counter statistic, test the alarm LEDs and buzzer, silence the alarm buzzer during an alarm event, or exit the menu system.



- 1) Perform a system test weekly by pressing the PRESS pushbutton, the system **MUST** be in a system normal or idle state (solid green LEDs). The lifetime pump run event counter statistic should display until the button is released, or for two seconds, whichever is greater. Then, the alarm LEDs should illuminate for two seconds each while cycling between red, green, blue, and off. The OLED screen should display a TESTING (COLOR) event to match the respective LEDs after the event statistic is displayed. Last, the buzzer should announce and the OLED screen should display a TESTING BUZZER event for two seconds.
- 2) Pressing the PRESS pushbutton after the system test has started will restart the test sequence from the beginning at the lifetime pump event counter statistic,
- 3) Press the PRESS pushbutton during an alarm event to silence the alarm buzzer.
- 4) The alarm condition will clear once the individual event is deactivated, which resets for the next alarm event.
- 5) The silence time is factory set to 24 hours, use the menu keypad to change the setting for alarm event silence time.

Note: When activated, system test will exit the menu system without saving and disable the menu system. Any events that are active while system test starts will not be shown, but will be tracked normally. Any newly activated event will deactivate the system test event.

Power Post™ Control Panel - USER GUIDE

Menu System

The menu system contains several menus and sub-menus. Use the menu keypad to navigate through active events, resettable and lifetime history statistics, and system settings which can be programmed to customize the system per application.

MAIN MENU - Blank Screen

When the system is idle and there has been no event activity or key pressed for at least 70 seconds, the OLED screen will be blank. Press any arrow key (up, down, left, or right) to wake the system, SYSTEM NORMAL will appear.

MAIN MENU - System Normal

From the SYSTEM NORMAL screen, press the MENU button to access the main menu and HAND/OFF AUTO will appear. Pressing the MENU button from a blank screen will also access the main menu.

1.0 | MAIN MENU - Hand-Off-Auto Pump Mode Selector

From the HAND/OFF AUTO screen, press right arrow key for menu to view system override options (see page 29). Press down arrow key to the RESETBLE HISTORY screen.

2.0 | MAIN MENU - Resettable History

From the RESETBLE HISTORY screen, press right arrow key for menu to view and clear statistics (see page 30). Press down arrow key to the SETTINGS screen.

3.0 | MAIN MENU - Settings

From the SETTINGS screen, press right arrow key for menu to enter password and program system settings (see pages 31-34). Press down arrow key to the LIFETIME HISTORY screen.

4.0 | MAIN MENU - Lifetime History

From the LIFETIME HISTORY screen, press right arrow key for menu to view statistics (see page 35). Press down arrow key to the MODEL / FIRMWARE screen.

5.0 | MAIN MENU - Model Name and Firmware Version

From the MODEL / FIRMWARE screen, press down arrow key to bring you back to the HAND/OFF AUTO screen.

Note: The down arrow key will cycle through all the main menu options until a specific option is selected using the right arrow key as displayed on the screen and described above. Press the test/silence pushbutton to exit the menu system.



Menu System (continued)

1.0 | MAIN MENU - Hand-Off-Auto Pump Mode Selector

From the HAND/OFF AUTO screen, press right arrow key to access the menu for system override options. Follow the steps below for each selection within this menu, factory set to AUTO.

1.1 Override System?

- i. Left arrow, exit without entering system override
- ii. Press MENU to accept question
- iii. HOLD TO RUN PUMP? will appear on the screen
- iv. LED indicators change to white (flashing)

Note: SYSTEM OVERRIDE appears on the screen after 60 seconds of no activity once the event is activated, white LEDs remain illuminated (flashing). Press the MENU button to return to the main menu screen, then press the right arrow key from the hand-off-auto screen to re-enter the system override menu. If system override is no longer desired, press the down arrow key to SYSTEM AUTO? (1.3) and press MENU. The screen will display SYSTEM NORMAL and LEDs change to green (solid) if the current state of the system is in normal operating conditions.

1.2 Hold to Pump Run?*

- i. Press and hold MENU for manual pump operation
- ii. LED indicators change to blue (solid)
- iii. PUMP RUN is displayed on the screen
- iv. Pump continues to run as long as MENU is pressed
- v. Release MENU to stop manual pump operation
- vi. Down arrow, moves to next question

Note: Pump Run and Pump Fail events will activate as normal. The steps above describe how manual operation of the pump will display during a pump run event. If a pump fail event occurs see supplemental instructions* below.

1.3 System Auto?

- i. Press MENU to accept question
- ii. SYSTEM NORMAL will appear on the screen
- iii. LED indicators change to green (solid)
- iv. The system switches back to automatic pump mode
- v. Press MENU to return to main menu

Note: The down arrow key will cycle between the menu questions until a specific question is selected by pressing the MENU button. Press the left arrow key to exit from any screen. Press the test/silence pushbutton to exit the menu system.

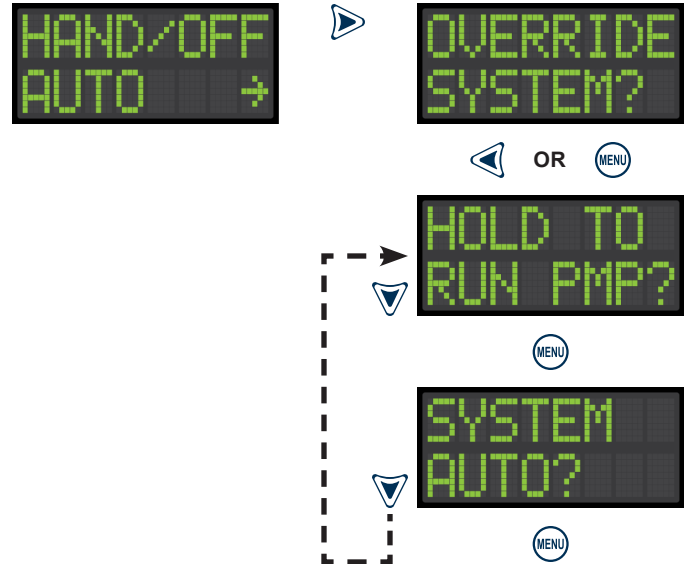

(*) Supplemental instructions during a Pump Fail event:

1.2 Hold to Pump Run?

- i. Press and hold MENU for manual pump operation
- ii. LED indicators change to purple (flashing)
- iii. PUMP FAIL is displayed on the screen
- iv. Pump Fail displayed as long as MENU is pressed
- v. Release MENU to stop manual pump operation
- vi. LED indicators change to white (flashing)
- vii. PUMP FAILURE and SYSTEM OVERRIDE are displayed on the screen alternating
- viii. Press MENU, PMP FAIL CLEAR? appears
- ix. Press MENU, CHECKING PMP FAIL appears
- x. System returns to SYSTEM OVERRIDE once the pump fail event has been cleared

Menu System (continued)

2.0 | MAIN MENU - Resettable History

From the RESETBLE HISTORY screen, press right arrow key to access the menu for event statistics and then press down arrow key for the available events within this menu.

- 2.1 Pump Run Stats
- 2.2 Extended Pump Run Stats
- 2.3 High Amp Stats
- 2.4 Pump Float Stats
- 2.5 Relay Stats
- 2.6 Dose On Stats (timed dosing only)
- 2.7 Peak On Stats (timed dosing only)
- 2.8 High Level Alarm Stats
- 2.9 Filter Alarm Stats
- 2.10 Pump Fail Stats
- 2.11 Relay Fail Stats
- 2.12 System Fail Stats (demand dose only)
- 2.13 Power Loss Stats

See pages 37-47 for individual stats of each event type listed above and data stored in the system. Each resettable history event stat has a clear history function. The non-volatile memory allows all settings and statistics to be retained during power outages.

Note: The down arrow key will cycle through all the resettable history menu options until a specific option is selected using the right arrow key as displayed on the screen. Press the left arrow key to exit from any screen. Press the test/silence pushbutton to exit the menu system.

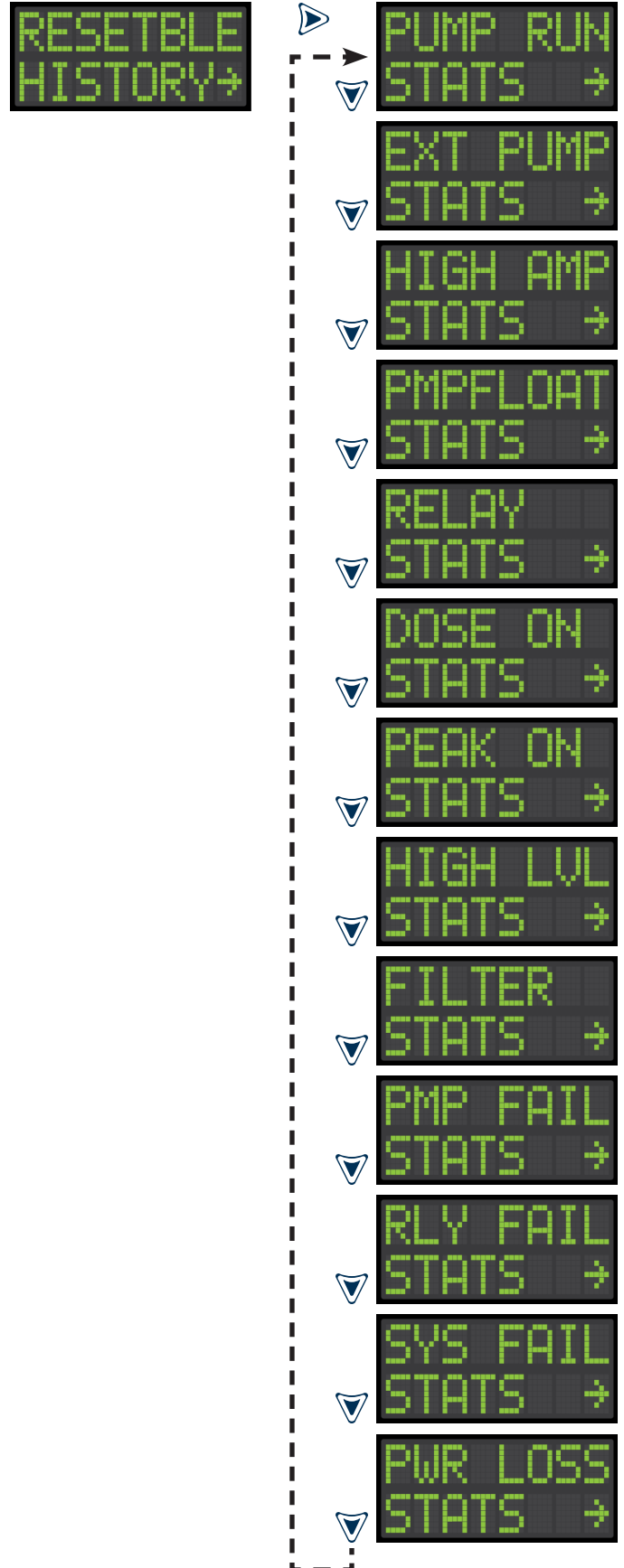

Power Post™ Control Panel - USER GUIDE

Menu System (continued)

3.0 | MAIN MENU - Settings | Part I

From the SETTINGS screen, press right arrow key to access the menu for system options which can be programmed, follow the steps below for each setting within this menu.

- 3.1 Password (factory set to 1919)
 - i. Password 0000 will appear on the screen
 - ii. Up or down arrow, increase/decrease selected digit
 - iii. Right arrow, moves cursor to the right (blinking)
 - iv. Press MENU to accept password
 - v. Left arrow, exit without entering
 - vi. Incorrect entry will exit user to the settings menu

Note: To change the password, use the up or down arrows until the password screen reappears, then enter numeric values between 0000-9999 and press MENU to save.

- 3.2 Normal LED Setting (factory set to LED On)
 - i. Normally LED Off?, press MENU to turn LED off
 - ii. Normally LED On?, press MENU to turn LED on

- 3.3 Pump Run LED Setting (factory set to LED On)
 - i. Pump Run LED Off?, press MENU to turn LED off
 - ii. Pump Run LED On?, press MENU to turn LED on

- 3.4 Silence Time Setting (factory set to 24 hours)
 - i. The current setting will appear on the screen
 - ii. Up or down arrow, increase/decrease selected digit
 - iii. Right arrow, moves cursor to the right (blinking)
 - iv. Press MENU to save changes
 - v. Left arrow, exit without entering

- 3.5 Extended Pump Run Time Setting (factory set to 30 min)
 - i. The current setting will appear on the screen
 - ii. Up or down arrow, increase/decrease selected digit
 - iii. Right arrow, moves cursor to the right (blinking)
 - iv. Press MENU to save changes
 - v. Left arrow, exit without entering

- 3.6 High Amp Level Setting (factory set to 15 Amps)
 - i. The current setting will appear on the screen
 - ii. Up or down arrow, increase/decrease selected digit
 - iii. Right arrow, moves cursor to the right (blinking)
 - iv. Press MENU to save changes
 - v. Left arrow, exit without entering

- 3.7 Gallons Per Minute Setting (factory set to Zero)
 - i. The current setting will appear on the screen
 - ii. Up or down arrow, increase/decrease selected digit
 - iii. Right arrow, moves cursor to the right (blinking)
 - iv. Press MENU to save changes
 - v. Left arrow, exit without entering

CAUTION: Before proceeding with the operation of this product, Alderon™ recommends changing factory settings to customize the system per application for desired operation.



Note: The down arrow key will cycle through all the settings menu options until a specific option is selected using the right arrow key or question mark as displayed on the screen. When a setting is changed, SETTINGS Saved will appear on the screen. Press the left arrow key to exit from any screen. Press the test/silence pushbutton to exit the menu system.

Menu System (continued)

3.0 | MAIN MENU - Settings | Part II

From the SETTINGS screen, press right arrow key to access the menu for system options which can be programmed, follow the steps below for each setting within this menu.

- 3.8 Dose Setting (factory set to Timed Dosing)
 - i. Demand Dose?, press MENU for Demand Dose
 - ii. Timed Dose?, press MENU for Timed Dose

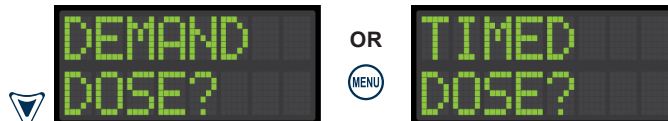

- 3.9 Float Setting** (factory set to Float Input)
 - i. In-line Float?, press MENU for In-line Float
 - ii. Float Input?, press MENU for Float Input

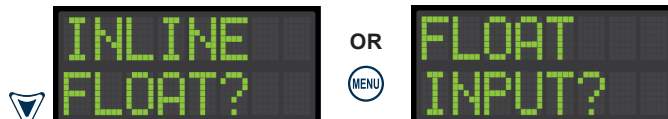

- 3.10 Dose Off Time Setting* (factory set to 10 seconds)
 - i. The current setting will appear on the screen
 - ii. Up or down arrow, increase/decrease selected digit
 - iii. Right arrow, moves cursor to the right (blinking)
 - iv. Press MENU to save changes
 - v. Left arrow, exit without entering

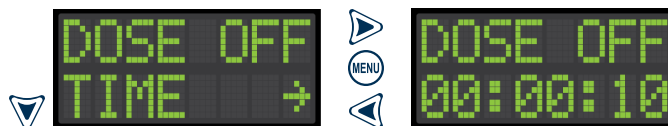

- 3.11 Dose On Time Setting* (factory set to 5 seconds)
 - i. The current setting will appear on the screen
 - ii. Up or down arrow, increase/decrease selected digit
 - iii. Right arrow, moves cursor to the right (blinking)
 - iv. Press MENU to save changes
 - v. Left arrow, exit without entering

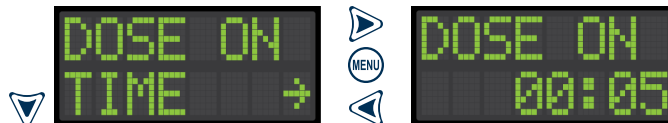

- 3.12 Peak Dose Off Time Setting* (factory set to 10 seconds)
 - i. The current setting will appear on the screen
 - ii. Up or down arrow, increase/decrease selected digit
 - iii. Right arrow, moves cursor to the right (blinking)
 - iv. Press MENU to save changes
 - v. Left arrow, exit without entering

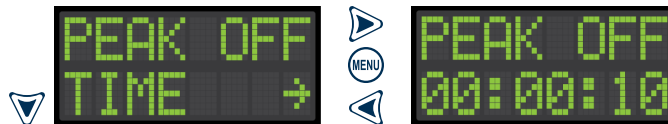

- 3.13 Peak Dose On Time Setting* (factory set to 5 seconds)
 - i. The current setting will appear on the screen
 - ii. Up or down arrow, increase/decrease selected digit
 - iii. Right arrow, moves cursor to the right (blinking)
 - iv. Press MENU to save changes
 - v. Left arrow, exit without entering

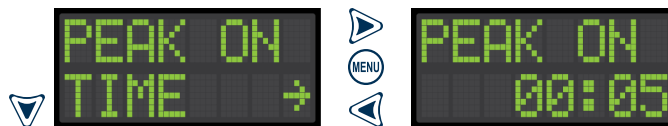

- 3.14 Minimum Peak Dose Cycles Setting* (factory set to 1)
 - i. The current setting will appear on the screen
 - ii. Up or down arrow, increase/decrease selected digit
 - iii. Right arrow, moves cursor to the right (blinking)
 - iv. Press MENU to save changes
 - v. Left arrow, exit without entering



Note: Enter a numeric value between 1-9

-----> (Down Arrow Key, Continue on Page 34)

Note: The down arrow key will cycle through all the settings menu options until a specific option is selected using the right arrow key or question mark as displayed on the screen. When a setting is changed, SETTINGS Saved will appear on the screen. Press the left arrow key to exit from any screen. Press the test/silence pushbutton to exit the menu system.

(*) Indicates setting for Timed Dose only
 (**) Indicates setting for Demand Dose only

Power Post™ Control Panel - USER GUIDE

Menu System (continued)

3.0 | MAIN MENU - Settings | Part III

From the SETTINGS screen, press right arrow key to access the menu for system options which can be programmed, follow the steps below for each setting within this menu.

- 3.15 End Dose Setting* (factory set to Stop Dose)
- i. Finish Dose?, press MENU for Finish Dose
 - ii. Stop Dose?, press MENU for Stop Dose

- 3.16 Buzzer Delay* (factory set to 20 seconds)
- i. The current setting will appear on the screen
 - ii. Up or down arrow, increase/decrease selected digit
 - iii. Right arrow, moves cursor to the right (blinking)
 - iv. Press MENU to save changes
 - v. Left arrow, exit without entering



(Down Arrow Key Cycles to Top of Menu, Back to Page 32)

Note: The down arrow key will cycle through all the settings menu options until a specific option is selected using the right arrow key or question mark as displayed on the screen. When a setting is changed, SETTINGS Saved will appear on the screen. Press the left arrow key to exit from any screen. Press the test/silence pushbutton to exit the menu system.

(*) Indicates setting for Timed Dose only

Menu System (continued)

4.0 | MAIN MENU - Lifetime History

From the LIFETIME HISTORY screen, press right arrow key to access the menu for event statistics and then press down arrow key for the available events within this menu.

- 4.1 Pump Run Stats
- 4.2 Extended Pump Run Stats
- 4.3 High Amp Stats
- 4.4 Pump Float Stats
- 4.5 Relay Stats
- 4.6 Dose On Stats (timed dosing only)
- 4.7 Peak On Stats (timed dosing only)
- 4.8 High Level Alarm Stats
- 4.9 Filter Alarm Stats
- 4.10 Pump Fail Stats
- 4.11 Relay Fail Stats
- 4.12 System Fail Stats (demand dose only)
- 4.13 Power Loss Stats

See pages 48-57 for individual stats of each event type listed above and data stored in the system. The lifetime statistics are non-resettable and are displayed in Title Case format for visual separation from the resettable statistics, which are displayed in UPPERCASE format. The non-volatile memory allows all settings and statistics to be retained during power outages.

Note: The down arrow key will cycle through all the lifetime history menu options until a specific option is selected using the right arrow key as displayed on the screen. Press the left arrow key to exit from any screen. Press the test/silence pushbutton to exit the menu system.

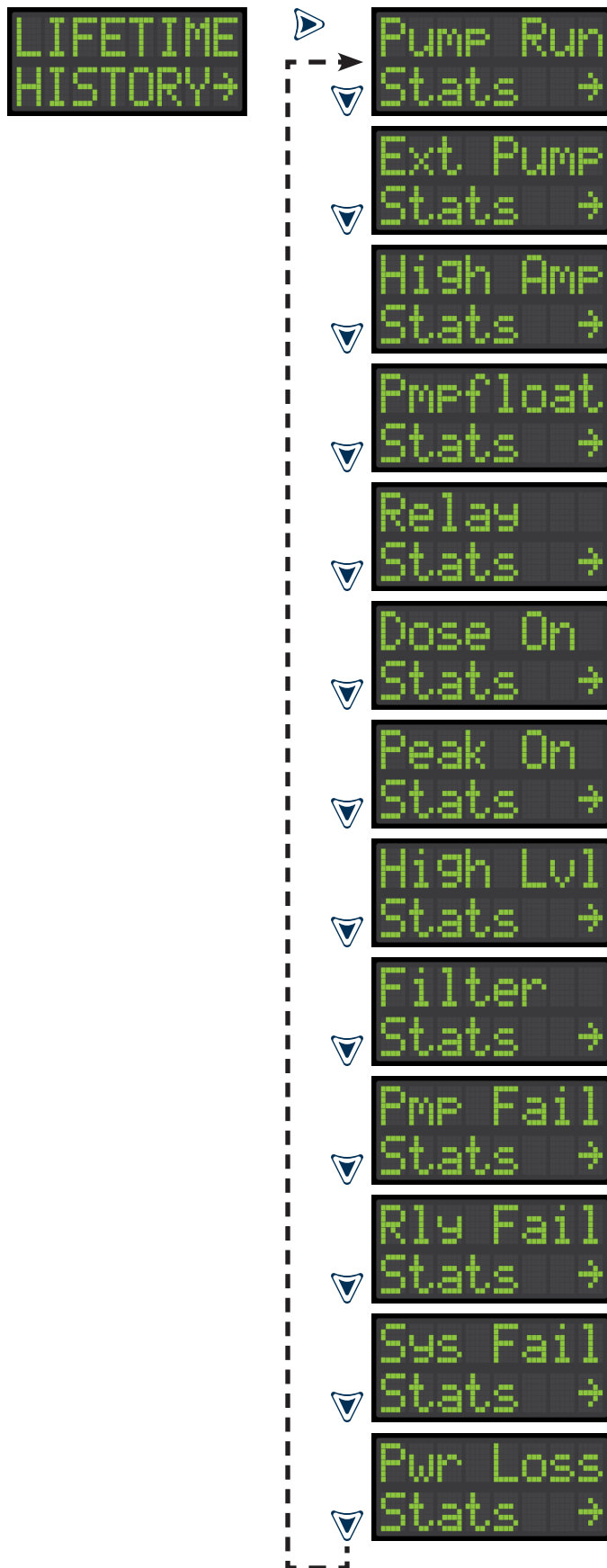

Power Post™ Control Panel - USER GUIDE

Menu System (continued)

5.0 | MAIN MENU - Model Name and Firmware Version

The MODEL and FIRMWARE screen will display the model name of the product and the version of firmware programmed.



6.0 | EVENT DISPLAYS

The system will display text on the OLED screen for the various system events, see list and examples below.

- | | |
|-----------------------------|-----------------------------|
| 6.1 Pump Run | 6.13 Checking Pump Fail |
| 6.2 Extended Pump Run Alarm | 6.14 Relay Failure |
| 6.3 High Amp Alarm | 6.15 Relay Fail Clear? |
| 6.4 Normal Dose On* | 6.16 Checking Relay Fail |
| 6.5 Normal Dose Off* | 6.17 System Failure** |
| 6.6 Peak Dose On* | 6.18 System Fail Clear?* |
| 6.7 Peak Dose Off* | 6.19 Checking System Fail** |
| 6.8 High Level Alarm | 6.20 Float Failure |
| 6.9 Filter Alarm | 6.21 Float Fail Clear? |
| 6.10 Power Loss Alarm | 6.22 Checking Float Fail |
| 6.11 Pump Failure | 6.23 System Override |
| 6.12 Pump Fail Clear? | 6.24 Testing Buzzer |

(*) Indicates event for Timed Dose only

(**) Indicates event for Demand Dose only



Resettable History Statistics

2.1 | RESETTABLE HISTORY - Pump Run Stats

From the PUMP RUN STATS screen, press right arrow key to access the menu for event statistics and then press down arrow key for the available stats within this menu.

- i. Pump Run Amps (last event)
- ii. Pump Run Average Amps
- iii. Pump Run Maximum Amps
- iv. Pump Run Minimum Amps
- v. Pump Run (last event)
- vi. Pump Run Average
- vii. Pump Run Maximum
- viii. Pump Run Minimum
- ix. Pump Run Elapsed Time
- x. Pump Run Event Counter
- xi. Pump Run Total Gallons Pumped
- xii. Clear History?

Note: The down arrow key will cycle through all the pump run stats. The gallons per minute (GPM) setting must be greater than the factory setting of zero or the total gallons pumped statistic will not be displayed. Press MENU when CLEAR HISTORY? text is displayed on the screen, which will reset all pump run stats and RESETBLE Saved will appear on the screen. Press the left arrow key to exit to the main resettable history events menu. Press the test/silence pushbutton to exit the menu system.

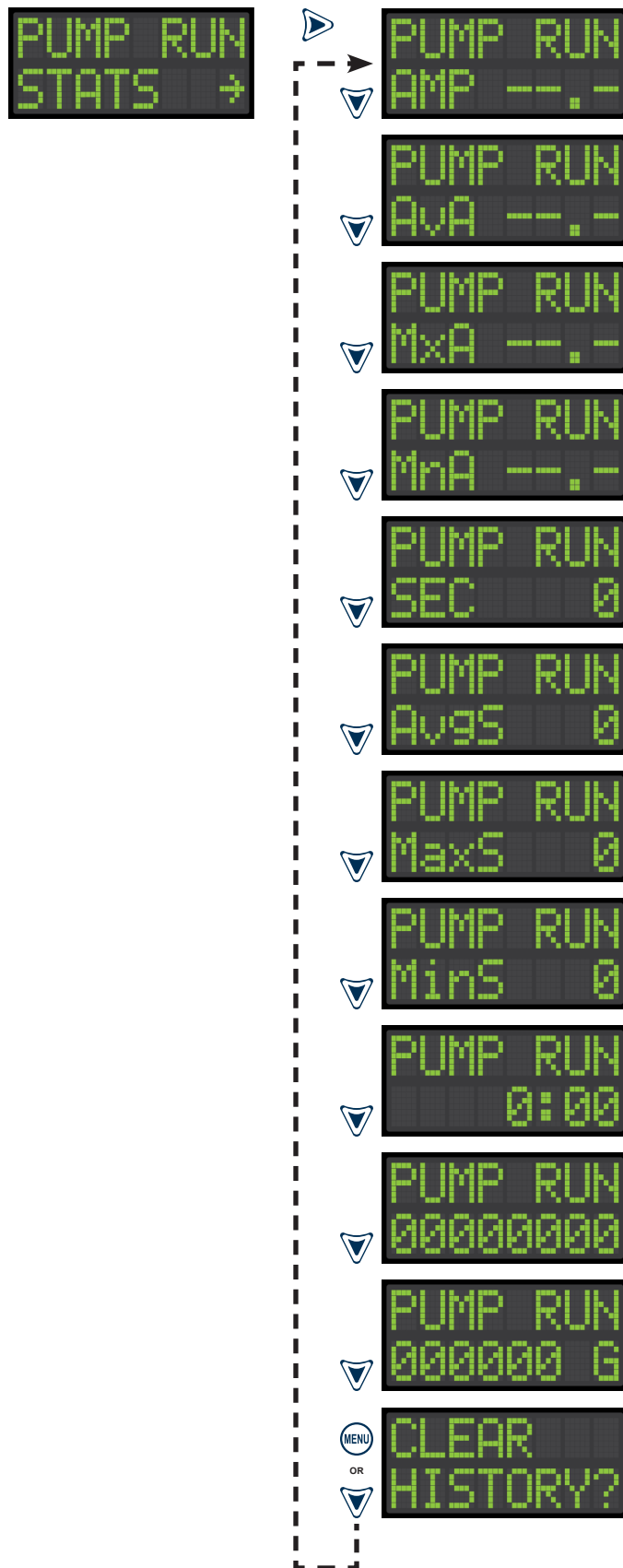

Resettable History Statistics (continued)

2.2 | RESETTABLE HISTORY - Extended Pump Run Stats

From the EXT PUMP STATS screen, press right arrow key to access the menu for event statistics and then press down arrow key for the available stats within this menu.

- i. Extended Pump Run Amps (last event)
- ii. Extended Pump Run Average Amps
- iii. Extended Pump Run Maximum Amps
- iv. Extended Pump Run Minimum Amps
- v. Extended Pump Run (last event)
- vi. Extended Pump Run Average
- vii. Extended Pump Run Maximum
- viii. Extended Pump Run Minimum
- ix. Extended Pump Run Elapsed Time
- x. Extended Pump Run Event Counter
- xi. Extended Pump Run Total Gallons Pumped
- xii. Clear History?

Note: The down arrow key will cycle through all the extended pump run stats. The gallons per minute (GPM) setting must be greater than the factory setting of zero or the total gallons pumped statistic will not be displayed. Press MENU when CLEAR HISTORY? text is displayed on the screen, which will reset all extended pump run stats and RESETBLE Saved will appear on the screen. Press the left arrow key to exit to the main resettable history events menu. Press the test/silence pushbutton to exit the menu system.

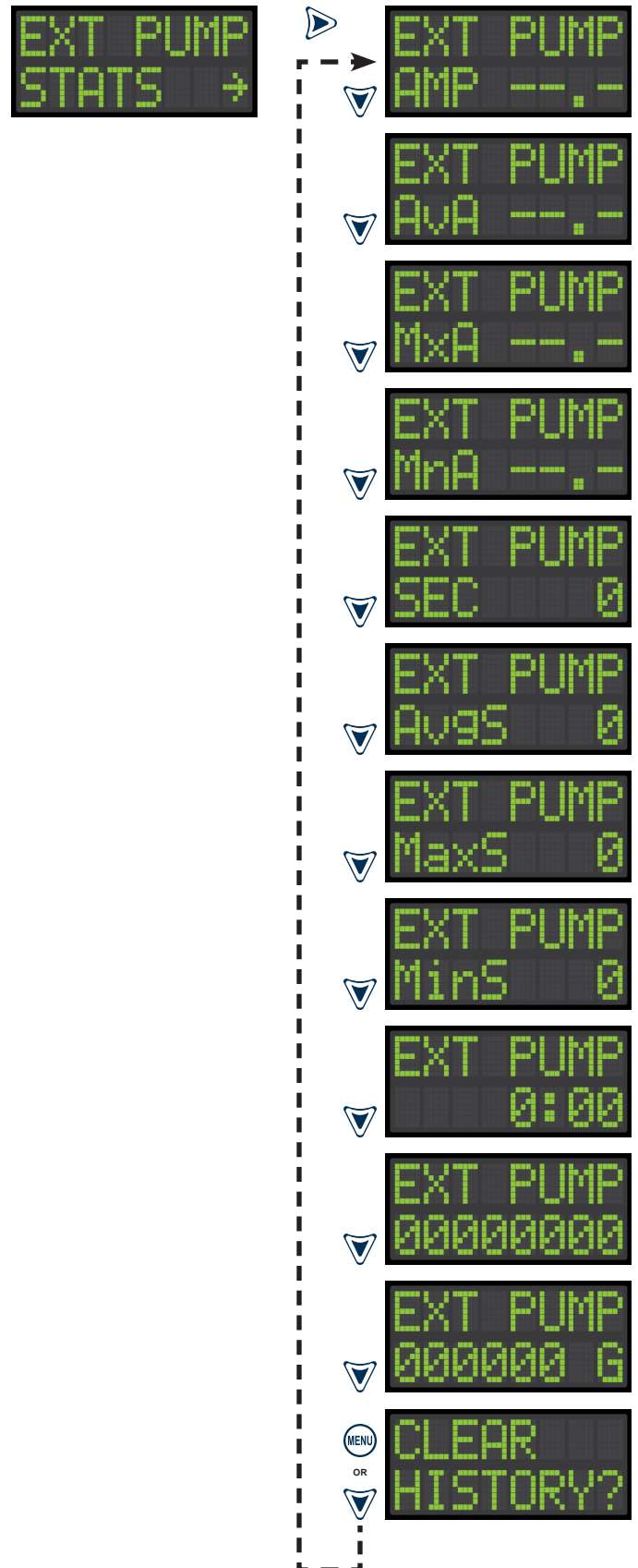

Resettable History Statistics (continued)

2.4 | RESETTABLE HISTORY - Pump Float Stats

From the PMPFLOAT STATS screen, press right arrow key to access the menu for event statistics and then press down arrow key for the available stats within this menu.

- i. Pump Float Event Counter
- ii. Clear History?

Note: The down arrow key cycles between the event counter and clear history. Press MENU when CLEAR HISTORY? text is displayed on the screen, which will reset all pump float stats and RESETBLE Saved will appear on the screen. Press the left arrow key to exit to the main resettable history events menu. Press the test/silence pushbutton to exit the menu system.

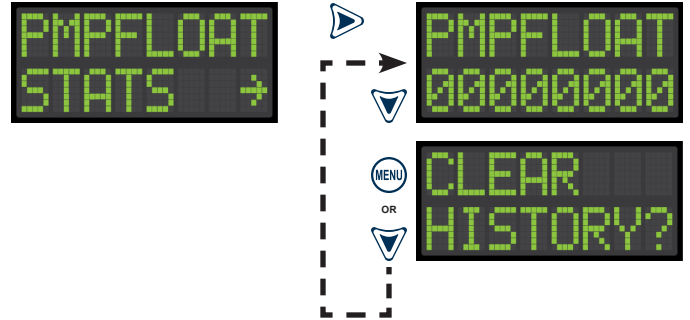

2.5 | RESETTABLE HISTORY - Relay Stats

From the RELAY STATS screen, press right arrow key to access the menu for event statistics and then press down arrow key for the available stats within this menu.

- i. Relay Event Counter
- ii. Clear History?

Note: The down arrow key cycles between the event counter and clear history. Press MENU when CLEAR HISTORY? text is displayed on the screen, which will reset all relay stats and RESETBLE Saved will appear on the screen. Press the left arrow key to exit to the main resettable history events menu. Press the test/silence pushbutton to exit the menu system.

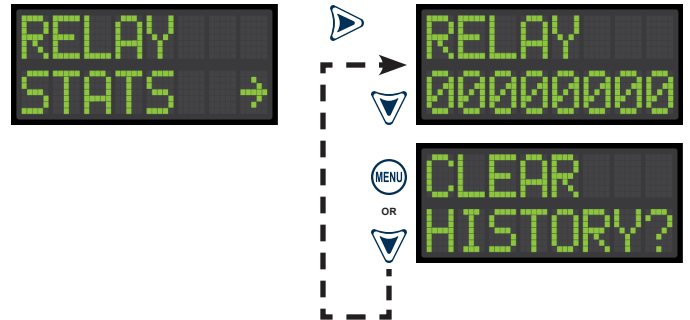

Resettable History Statistics (continued)

2.6 | RESETTABLE HISTORY - Dose On Stats

From the DOSE ON STATS screen, press right arrow key to access the menu for event statistics and then press down arrow key for the available stats within this menu.

- i. Dose On (last event)
- ii. Dose On Average
- iii. Dose On Maximum
- iv. Dose On Minimum
- v. Dose On Elapsed Time
- vi. Dose On Event Counter
- vii. Clear History?

Note: The down arrow key will cycle through all the dose on stats. Press MENU when CLEAR HISTORY? text is displayed on the screen, which will reset all dose on stats and RESETBLE Saved will appear on the screen. There are no statistics for a dose off event. Press the left arrow key to exit to the main resettable history events menu. Press the test/silence pushbutton to exit the menu system.

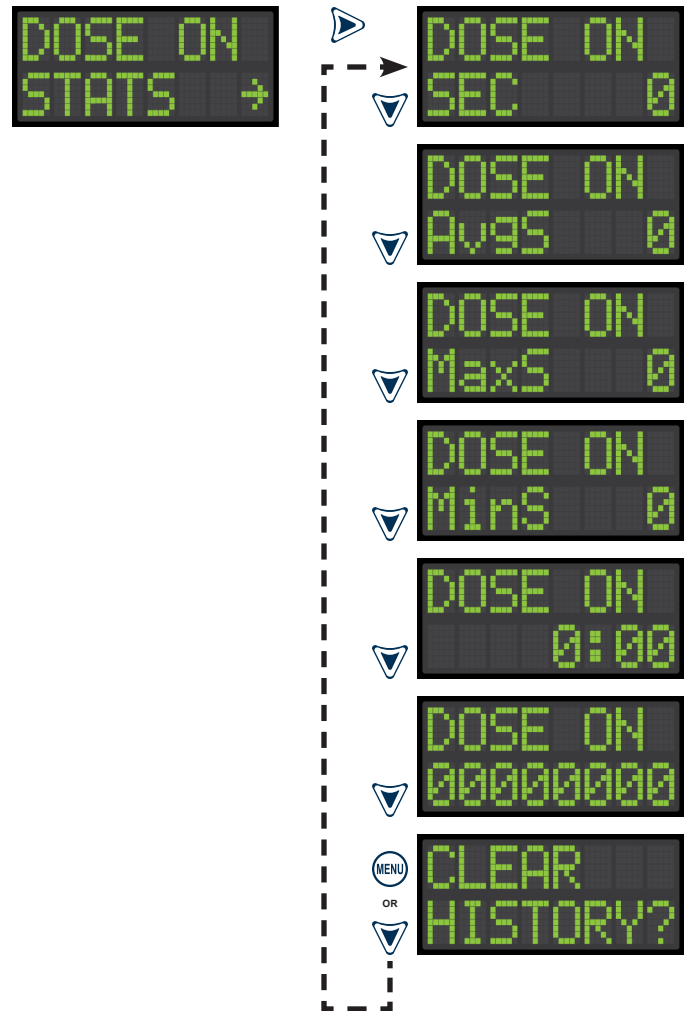

Resettable History Statistics (continued)

2.7 | RESETTABLE HISTORY - Peak On Stats

From the PEAK ON STATS screen, press right arrow key to access the menu for event statistics and then press down arrow key for the available stats within this menu.

- i. Peak On (last event)
- ii. Peak On Average
- iii. Peak On Maximum
- iv. Peak On Minimum
- v. Peak On Elapsed Time
- vi. Peak On Event Counter
- vii. Clear History?

Note: The down arrow key will cycle through all the peak on stats. Press MENU when CLEAR HISTORY? text is displayed on the screen, which will reset all peak on stats and RESETBLE Saved will appear on the screen. There are no statistics for a peak off event. Press the left arrow key to exit to the main resettable history events menu. Press the test/silence pushbutton to exit the menu system.

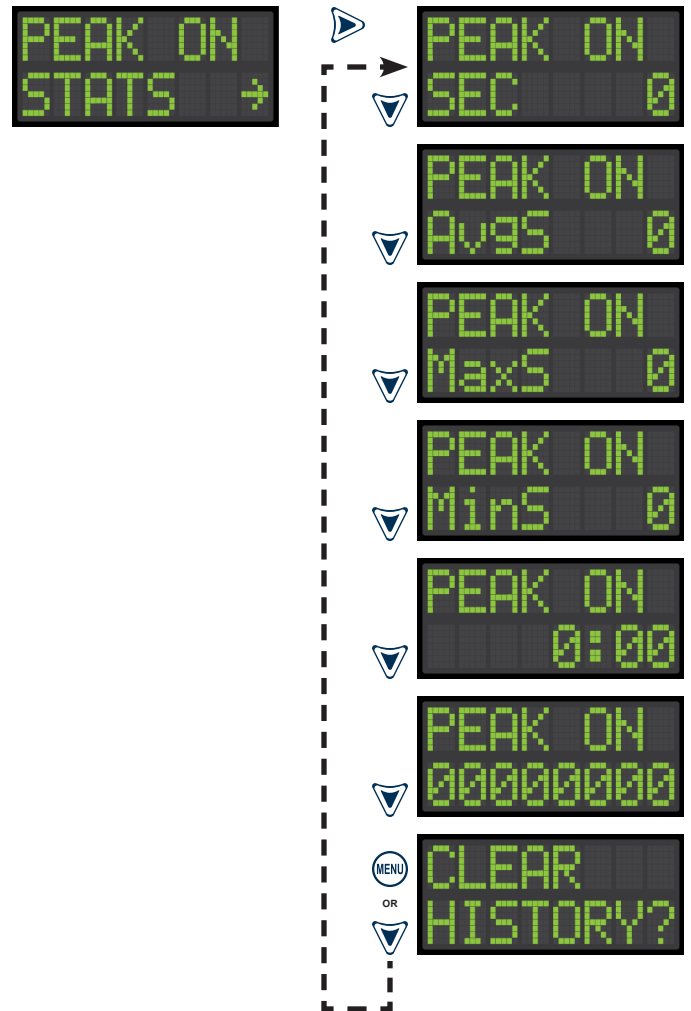

Resettable History Statistics (continued)

2.8 | RESETTABLE HISTORY - High Level Alarm Stats

From the HIGH LVL STATS screen, press right arrow key to access the menu for event statistics and then press down arrow key for the available stats within this menu.

- i. High Level Alarm (last event)
- ii. High Level Alarm Average
- iii. High Level Alarm Maximum
- iv. High Level Alarm Minimum
- v. High Level Alarm Elapsed Time
- vi. High Level Alarm Event Counter
- vii. Clear History?

Note: The down arrow key will cycle through all the high level alarm stats. Press MENU when CLEAR HISTORY? text is displayed on the screen, which will reset all high level alarm stats and RESETBLE Saved will appear on the screen. Press the left arrow key to exit to the main resettable history events menu. Press the test/silence pushbutton to exit the menu system.

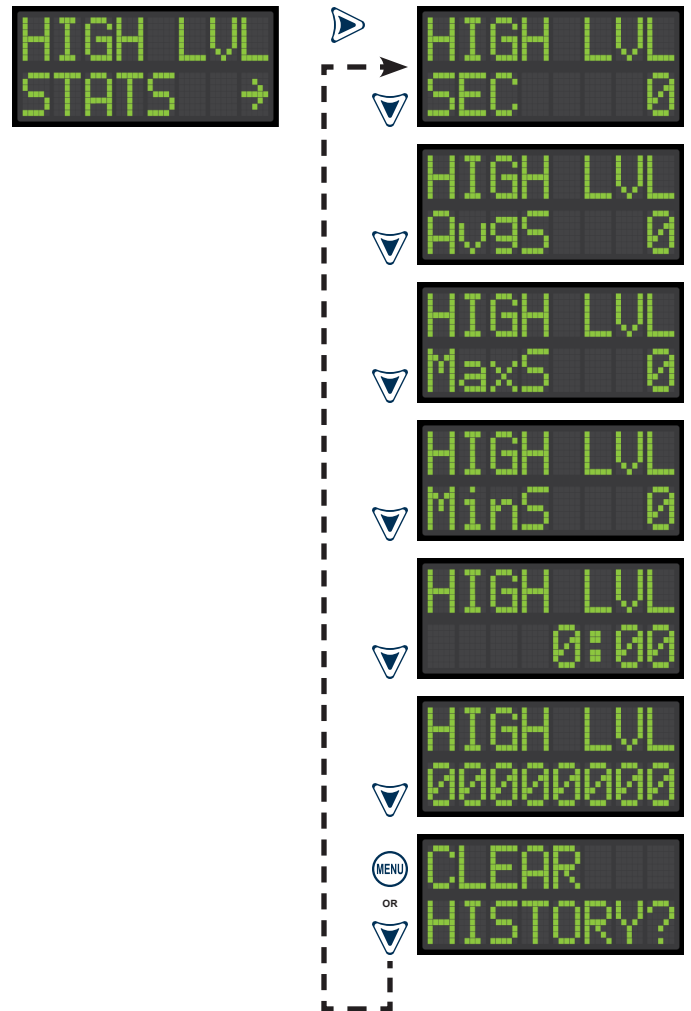

Resettable History Statistics (continued)

2.9 | RESETTABLE HISTORY - Filter Alarm Stats

From the FILTER STATS screen, press right arrow key to access the menu for event statistics and then press down arrow key for the available stats within this menu.

- i. Filter Alarm (last event)
- ii. Filter Alarm Average
- iii. Filter Alarm Maximum
- iv. Filter Alarm Minimum
- v. Filter Alarm Elapsed Time
- vi. Filter Alarm Event Counter
- vii. Clear History?

Note: The down arrow key will cycle through all the filter alarm stats. Press MENU when CLEAR HISTORY? text is displayed on the screen, which will reset all filter alarm stats and RESETBLE Saved will appear on the screen. Press the left arrow key to exit to the main resettable history events menu. Press the test/silence pushbutton to exit the menu system.

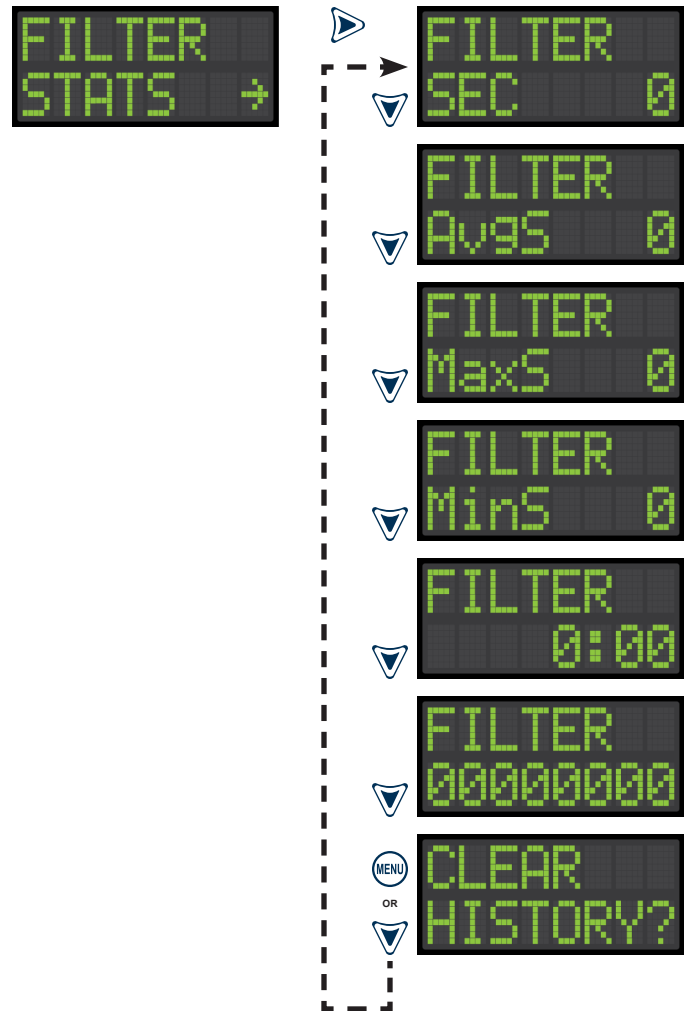

Resettable History Statistics (continued)

2.10 | RESETTABLE HISTORY - Pump Fail Stats

From the PMP FAIL STATS screen, press right arrow key to access the menu for event statistics and then press down arrow key for the available stats within this menu.

- i. Pump Fail (last event)
- ii. Pump Fail Average
- iii. Pump Fail Maximum
- iv. Pump Fail Minimum
- v. Pump Fail Elapsed Time
- vi. Pump Fail Event Counter
- vii. Clear History?

Note: The down arrow key will cycle through all the pump fail stats. Press MENU when CLEAR HISTORY? text is displayed on the screen, which will reset all pump fail stats and RESETBLE Saved will appear on the screen. Press the left arrow key to exit to the main resettable history events menu. Press the test/silence pushbutton to exit the menu system.

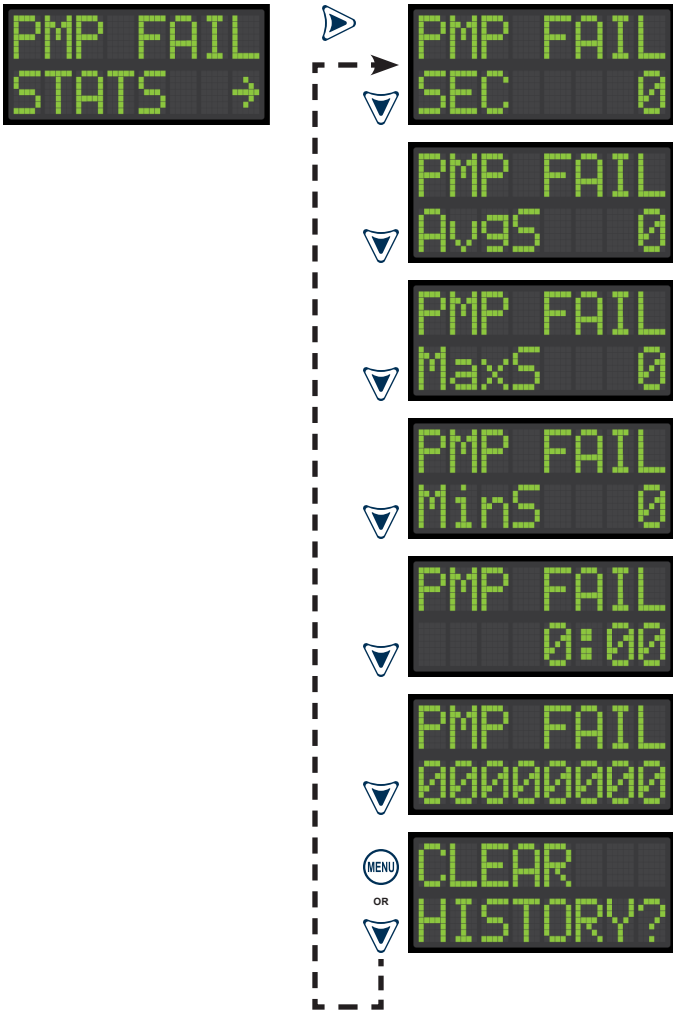

Resettable History Statistics (continued)

2.11 | RESETTABLE HISTORY - Relay Fail Stats

From the RLY FAIL STATS screen, press right arrow key to access the menu for event statistics and then press down arrow key for the available stats within this menu.

- i. Relay Fail (last event)
- ii. Relay Fail Average
- iii. Relay Fail Maximum
- iv. Relay Fail Minimum
- v. Relay Fail Elapsed Time
- vi. Relay Event Counter
- vii. Clear History?

Note: The down arrow key will cycle through all the relay fail stats. Press MENU when CLEAR HISTORY? text is displayed on the screen, which will reset all relay fail stats and RESETBLE Saved will appear on the screen. Press the left arrow key to exit to the main resettable history events menu. Press the test/silence pushbutton to exit the menu system.

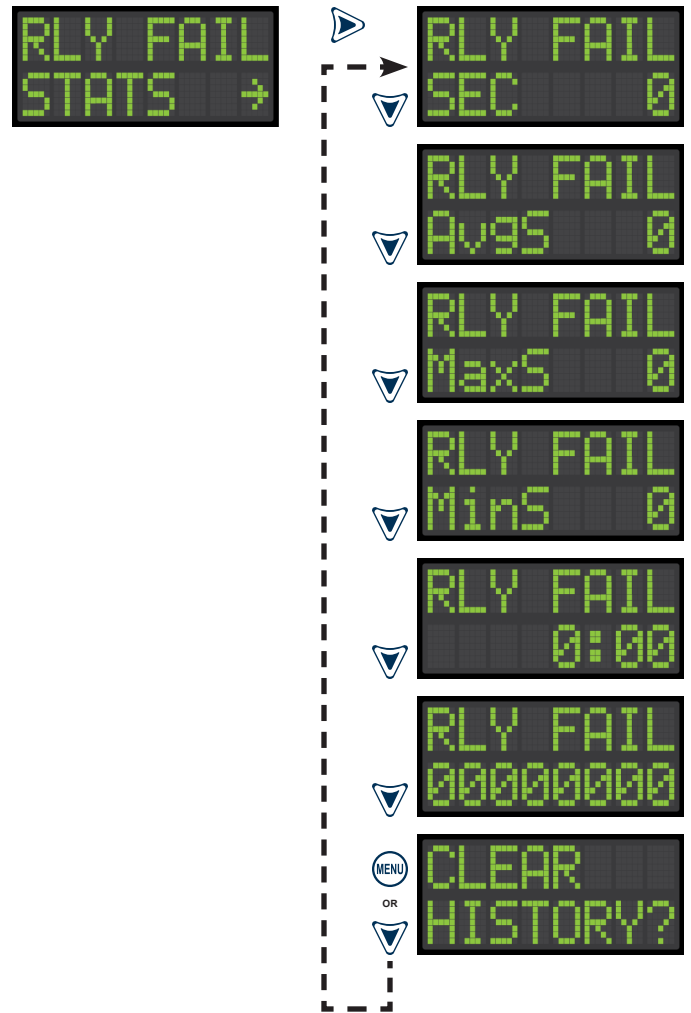

Resettable History Statistics (continued)

2.12 | RESETTABLE HISTORY - System Fail Stats

From the SYS FAIL STATS screen, press right arrow key to access the menu for event statistics and then press down arrow key for the available stats within this menu.

- i. System Fail (last event)
- ii. System Fail Average
- iii. System Fail Maximum
- iv. System Fail Minimum
- v. System Fail Elapsed Time
- vi. System Fail Event Counter
- vii. Clear History?

Note: The down arrow key will cycle through all the system fail stats. Press MENU when CLEAR HISTORY? text is displayed on the screen, which will reset all system fail stats and RESETBLE Saved will appear on the screen. Press the left arrow key to exit to the main resettable history events menu. Press the test/silence pushbutton to exit the menu system.

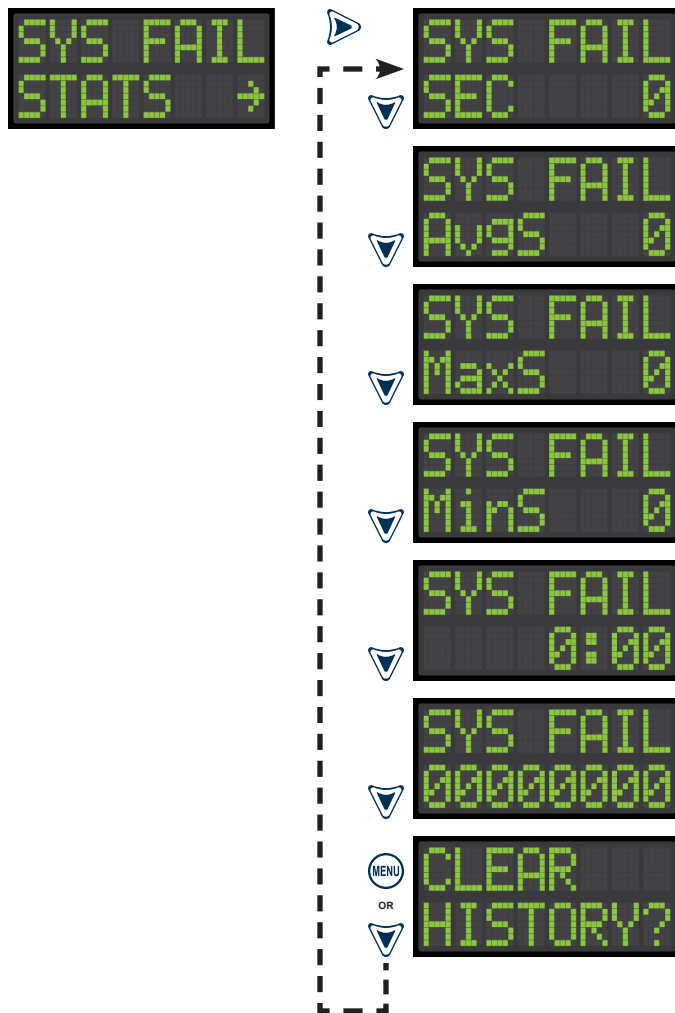

2.13 | RESETTABLE HISTORY - Power Loss Stats

From the PWR LOSS STATS screen, press right arrow key to access the menu for event statistics and then press down arrow key for the available stats within this menu.

- i. Power Loss Event Counter
- ii. Clear History?

Note: The down arrow key cycles between the event counter and clear history. Press MENU when CLEAR HISTORY? text is displayed on the screen, which will reset all power loss stats and RESETBLE Saved will appear on the screen. Press the left arrow key to exit to the main resettable history events menu. Press the test/silence pushbutton to exit the menu system.

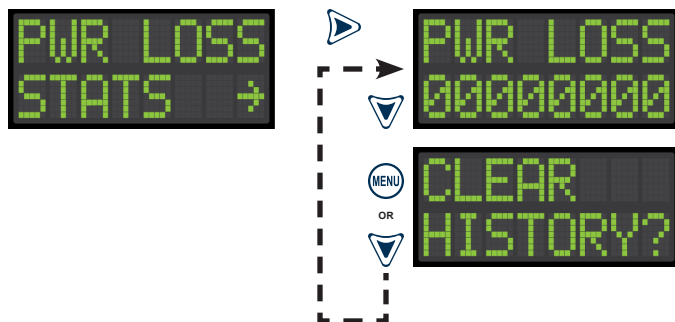

Lifetime History Statistics

4.1 | LIFETIME HISTORY - Pump Run Stats

From the Pump Run Stats screen, press right arrow key to access the menu for event statistics and then press down arrow key for the available stats within this menu.

- i. Pump Run Amps (last event)
- ii. Pump Run Average Amps
- iii. Pump Run Maximum Amps
- iv. Pump Run Minimum Amps
- v. Pump Run (last event)
- vi. Pump Run Average
- vii. Pump Run Maximum
- viii. Pump Run Minimum
- ix. Pump Run Elapsed Time
- x. Pump Run Event Counter
- xi. Pump Run Total Gallons Pumped

Note: The down arrow key will cycle through all the pump run stats. The gallons per minute (GPM) setting must be greater than the factory setting of zero or the total gallons pumped statistic will not be displayed. Press the left arrow key to exit to the main lifetime history events menu. Press the test/silence pushbutton to exit the menu system.

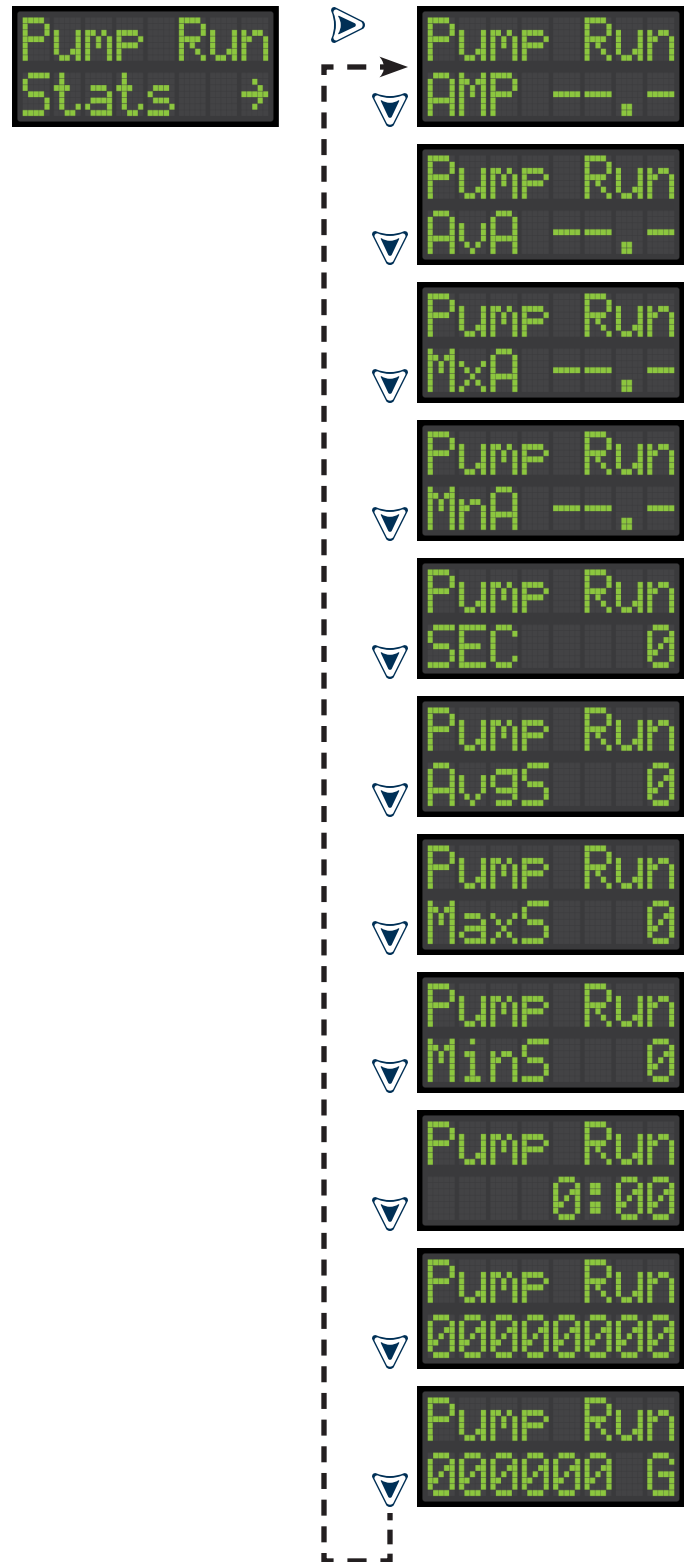

Lifetime History Statistics (continued)

4.2 | LIFETIME HISTORY - Extended Pump Run Stats

From the Ext Pump Stats screen, press right arrow key to access the menu for event statistics and then press down arrow key for the available stats within this menu.

- i. Extended Pump Run Amps (last event)
- ii. Extended Pump Run Average Amps
- iii. Extended Pump Run Maximum Amps
- iv. Extended Pump Run Minimum Amps
- v. Extended Pump Run (last event)
- vi. Extended Pump Run Average
- vii. Extended Pump Run Maximum
- viii. Extended Pump Run Minimum
- ix. Extended Pump Run Elapsed Time
- x. Extended Pump Run Event Counter
- xi. Extended Pump Run Total Gallons Pumped

Note: The down arrow key will cycle through all the extended pump run stats. The gallons per minute (GPM) setting must be greater than the factory setting of zero or the total gallons pumped statistic will not be displayed. Press the left arrow key to exit to the main lifetime history events menu. Press the test/silence pushbutton to exit the menu system.

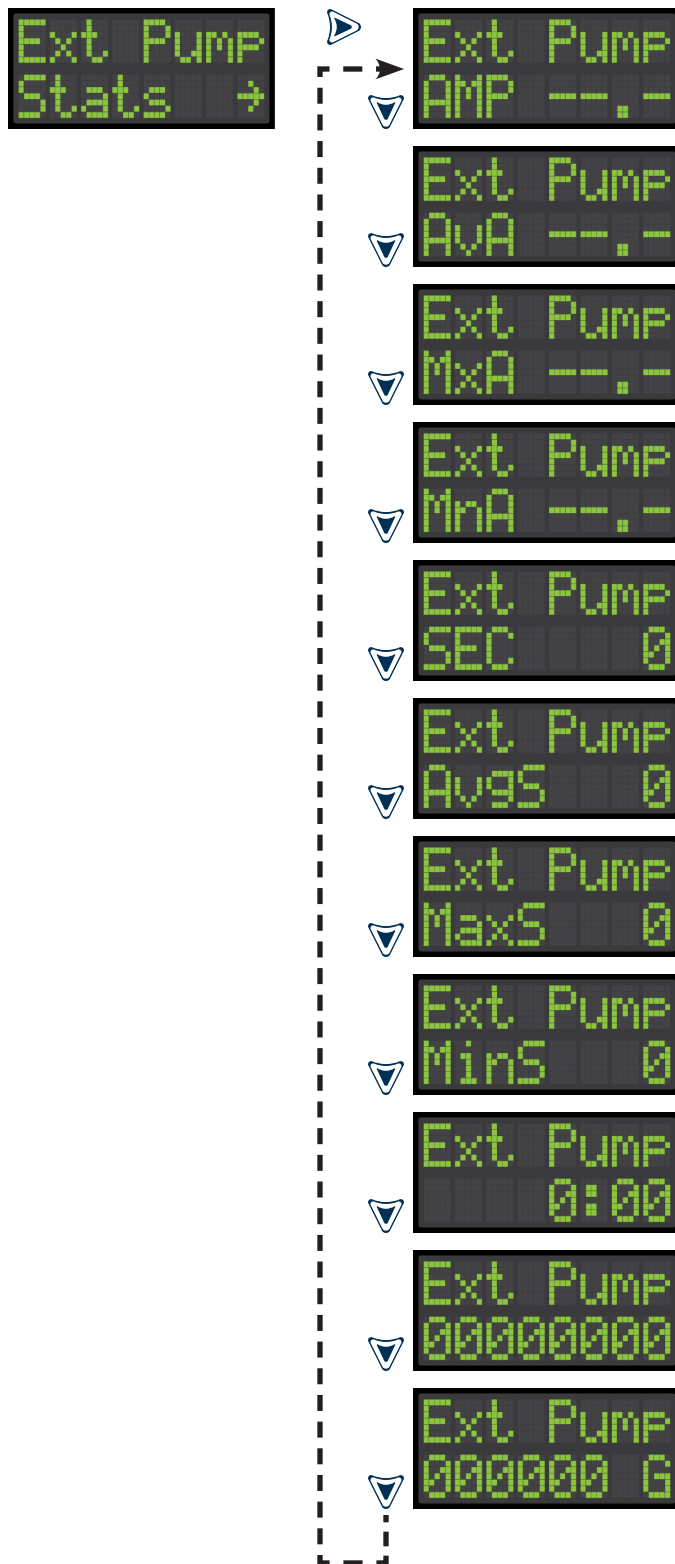

Lifetime History Statistics (continued)

4.3 | LIFETIME HISTORY - High Amp Stats

From the High Amp Stats screen, press right arrow key to access the menu for event statistics and then press down arrow key for the available stats within this menu.

- i. High Amp Amps (last event)
- ii. High Amp Average Amps
- iii. High Amp Maximum Amps
- iv. High Amp Minimum Amps
- v. High Amp (last event)
- vi. High Amp Average
- vii. High Amp Maximum
- viii. High Amp Minimum
- ix. High Amp Elapsed Time
- x. High Amp Event Counter

Note: The down arrow key will cycle through all the high amp stats. Press the left arrow key to exit to the main lifetime history events menu. Press the test/silence pushbutton to exit the menu system.

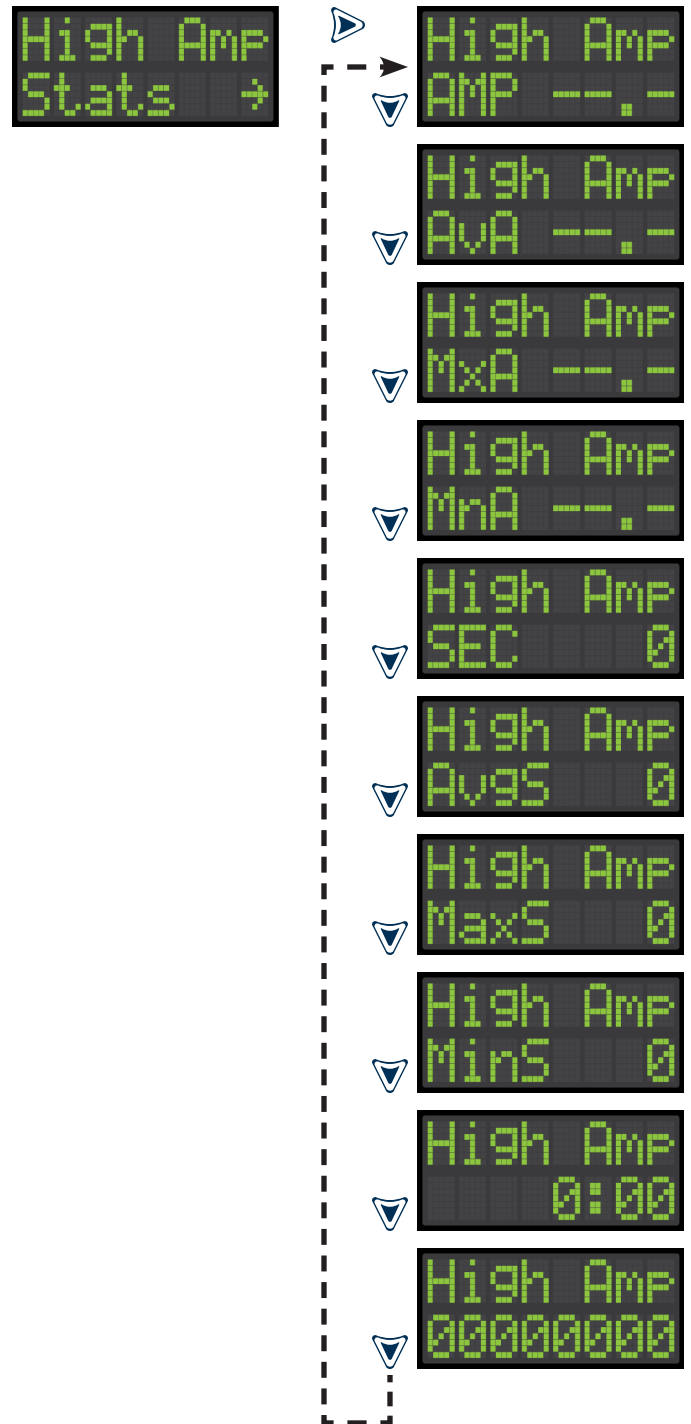

Lifetime History Statistics (continued)

4.4 | LIFETIME HISTORY - Pump Float Stats

From the Pmpfloat Stats screen, press right arrow key to access the event statistic within this menu.

- i. Pump Float Event Counter

Note: Press the left arrow key to exit to the main lifetime history events menu. Press the test/silence pushbutton to exit the menu system.

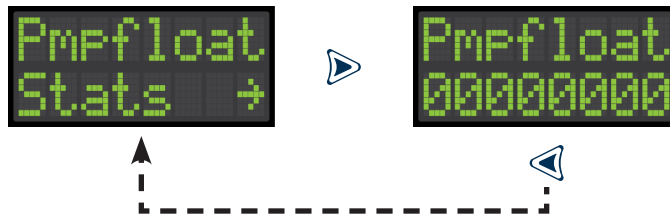

4.5 | LIFETIME HISTORY - Relay Stats

From the Relay Stats screen, press right arrow key to access the event statistic within this menu.

- i. Relay Event Counter

Note: Press the left arrow key to exit to the main lifetime history events menu. Press the test/silence pushbutton to exit the menu system.

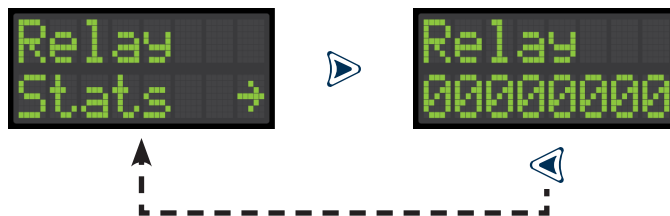

4.6 | LIFETIME HISTORY - Dose On Stats

From the Dose On Stats screen, press right arrow key to access the menu for event statistics and then press down arrow key for the available stats within this menu.

- i. Dose On (last event)
- ii. Dose On Average
- iii. Dose On Maximum
- iv. Dose On Minimum
- v. Dose On Elapsed Time
- vi. Dose On Event Counter

Note: The down arrow key will cycle through all the dose on stats. There are no statistics for a dose off event. Press the left arrow key to exit to the main lifetime history events menu. Press the test/silence pushbutton to exit the menu system.

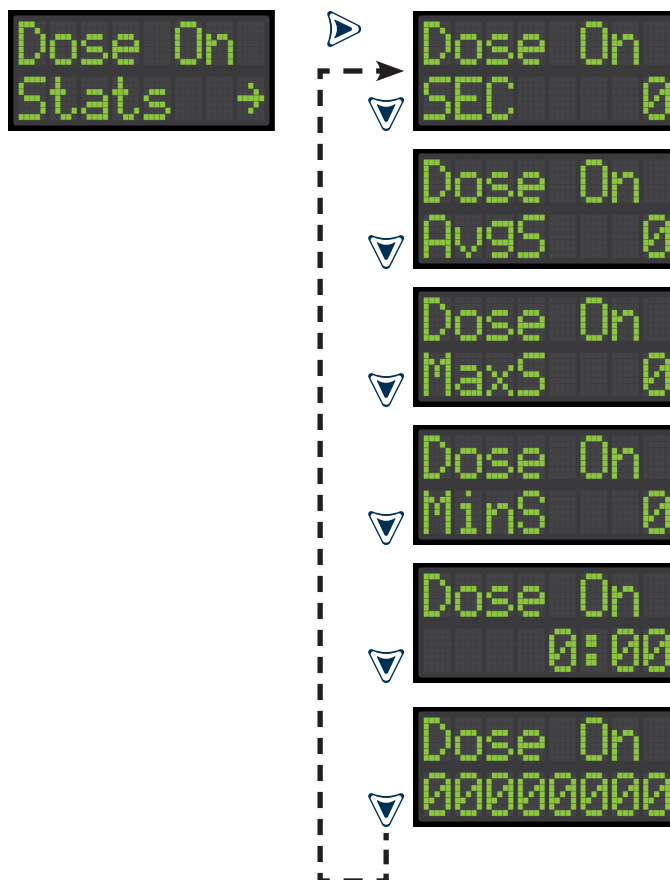

Lifetime History Statistics (continued)

4.7 | LIFETIME HISTORY - Peak On Stats

From the Peak On Stats screen, press right arrow key to access the menu for event statistics and then press down arrow key for the available stats within this menu.

- i. Peak On (last event)
- ii. Peak On Average
- iii. Peak On Maximum
- iv. Peak On Minimum
- v. Peak On Elapsed Time
- vi. Peak On Event Counter

Note: The down arrow key will cycle through all the peak on stats. There are no statistics for a peak off event. Press the left arrow key to exit to the main lifetime history events menu. Press the test/silence pushbutton to exit the menu system.

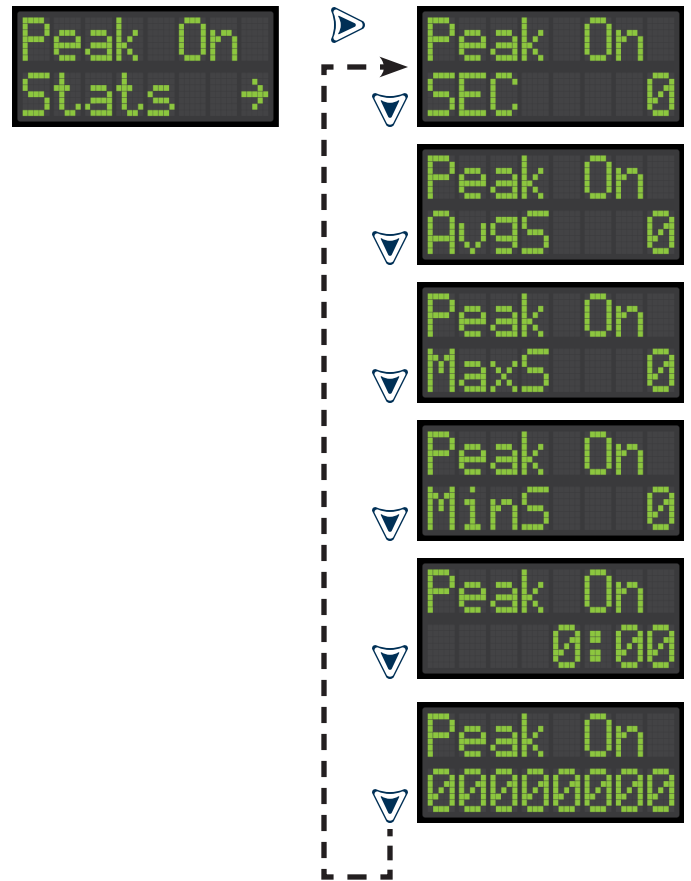

Lifetime History Statistics (continued)

4.8 | LIFETIME HISTORY - High Level Alarm Stats

From the High Lvl Stats screen, press right arrow key to access the menu for event statistics and then press down arrow key for the available stats within this menu.

- i. High Level Alarm (last event)
- ii. High Level Alarm Average
- iii. High Level Alarm Maximum
- iv. High Level Alarm Minimum
- v. High Level Alarm Elapsed Time
- vi. High Level Alarm Event Counter

Note: The down arrow key will cycle through all the high level alarm stats. Press the left arrow key to exit to the main lifetime history events menu. Press the test/silence pushbutton to exit the menu system.

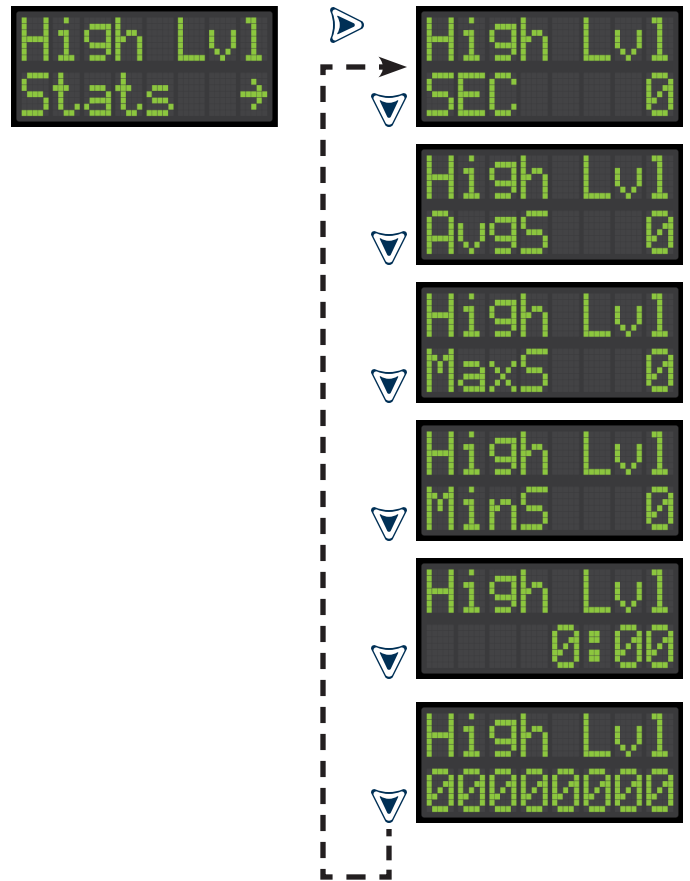

Lifetime History Statistics (continued)

4.9 | LIFETIME HISTORY - Filter Alarm Stats

From the Filter Stats screen, press right arrow key to access the menu for event statistics and then press down arrow key for the available stats within this menu.

- i. Filter Alarm (last event)
- ii. Filter Alarm Average
- iii. Filter Alarm Maximum
- iv. Filter Alarm Minimum
- v. Filter Alarm Elapsed Time
- vi. Filter Alarm Event Counter

Note: The down arrow key will cycle through all the filter alarm stats. Press the left arrow key to exit to the main lifetime history events menu. Press the test/silence pushbutton to exit the menu system.

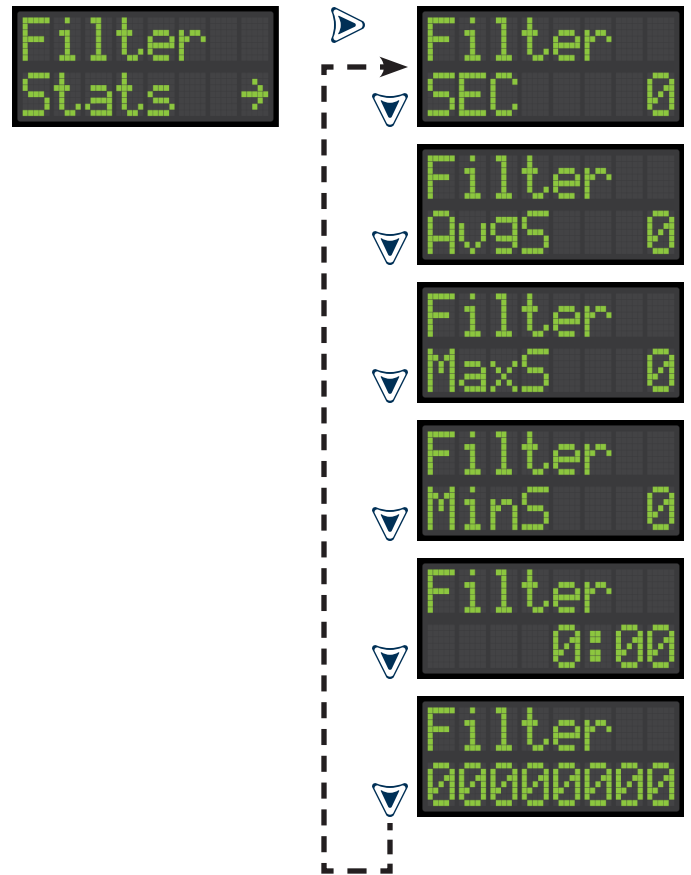

Lifetime History Statistics (continued)

4.10 | LIFETIME HISTORY - Pump Fail Stats

From the Pmp Fail Stats screen, press right arrow key to access the menu for event statistics and then press down arrow key for the available stats within this menu.

- i. Pump Fail (last event)
- ii. Pump Fail Average
- iii. Pump Fail Maximum
- iv. Pump Fail Minimum
- v. Pump Fail Elapsed Time
- vi. Pump Fail Event Counter

Note: The down arrow key will cycle through all the pump fail stats. Press the left arrow key to exit to the main lifetime history events menu. Press the test/silence pushbutton to exit the menu system.

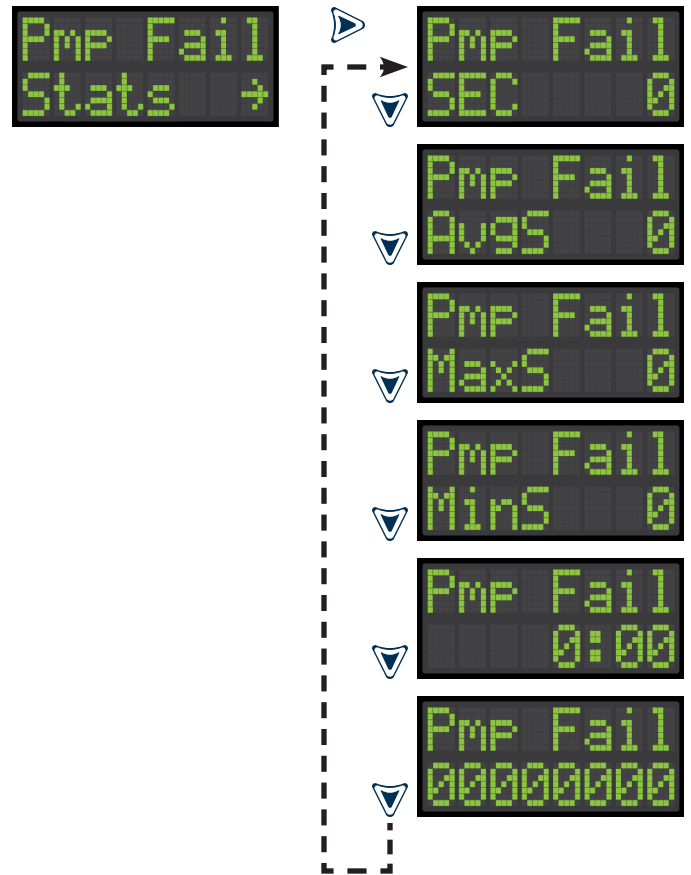

Lifetime History Statistics (continued)

4.11 | LIFETIME HISTORY - Relay Fail Stats

From the Rly Fail Stats screen, press right arrow key to access the menu for event statistics and then press down arrow key for the available stats within this menu.

- i. Relay Fail (last event)
- ii. Relay Fail Average
- iii. Relay Fail Maximum
- iv. Relay Fail Minimum
- v. Relay Fail Elapsed Time
- vi. Relay Fail Event Counter

Note: The down arrow key will cycle through all the relay fail stats. Press the left arrow key to exit to the main lifetime history events menu. Press the test/silence pushbutton to exit the menu system.

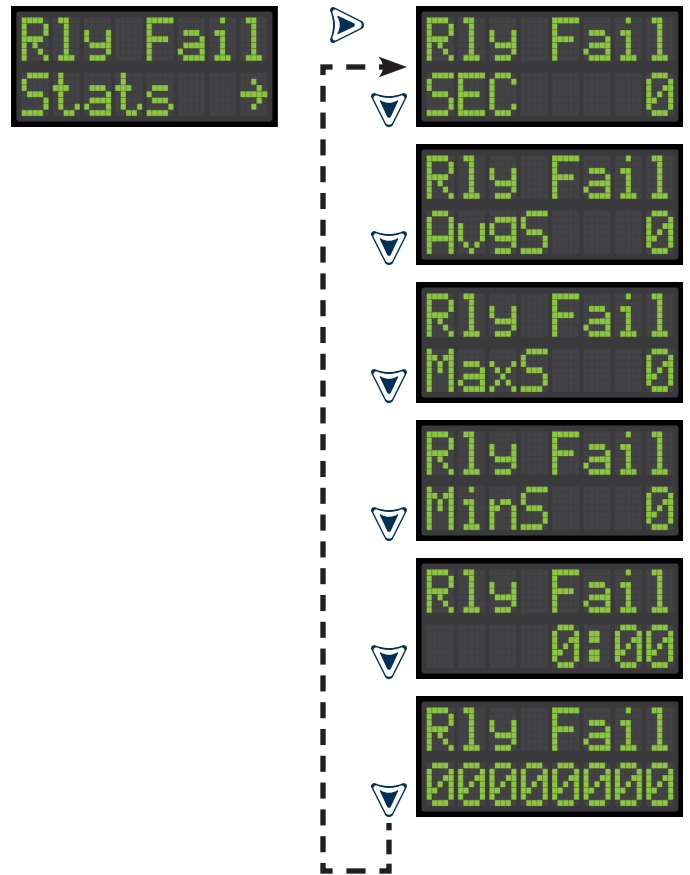

Lifetime History Statistics (continued)

4.12 | LIFETIME HISTORY - System Fail Stats

From the Sys Fail Stats screen, press right arrow key to access the menu for event statistics and then press down arrow key for the available stats within this menu.

- i. System Fail (last event)
- ii. System Fail Average
- iii. System Fail Maximum
- iv. System Fail Minimum
- v. System Fail Elapsed Time
- vi. System Fail Event Counter

Note: The down arrow key will cycle through all the system fail stats. Press the left arrow key to exit to the main lifetime history events menu. Press the test/silence pushbutton to exit the menu system.

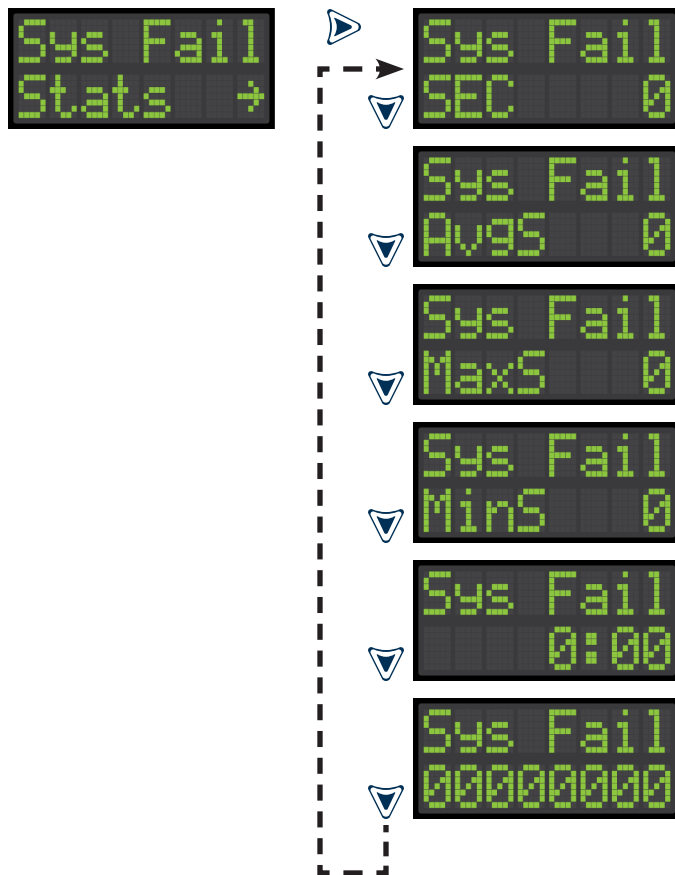

4.13 | LIFETIME HISTORY - Power Loss Stats

From the Pwr Loss Stats screen, press right arrow key to access the event statistic within this menu.

- i. Power Loss Event Counter

Note: Press the left arrow key to exit to the main lifetime history events menu. Press the test/silence pushbutton to exit the menu system.

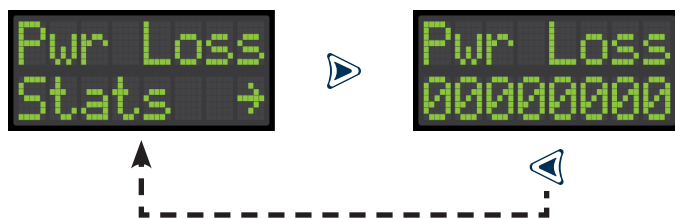

Power Post™ Control Panel - USER GUIDE

Menu System Flow (text only)

MAIN MENU

- 0.0 SYSTEM NORMAL
- 1.0 HAND/OFF AUTO (→)
- 2.0 RESETTABLE HISTORY (→)
- 3.0 SETTINGS (→)
- 4.0 LIFETIME HISTORY (→)
- 5.0 PPCP 1.0.0 (model/firmware)

1.0 | HAND/OFF AUTO

- 1.1 OVERRIDE SYSTEM?; press menu button to accept question
- 1.2 HOLD TO RUN PUMP?; press and hold menu button for manual operation of the pump
- 1.3 SYSTEM AUTO?; press menu button to accept question

2.0 | RESETTABLE HISTORY

- 2.1 PUMP RUN STATS (→)
 - i. Pump Run Amps (last event), Average Amps, Maximum Amps, and Minimum Amps
 - ii. Pump Run (last event), Average, Maximum, Minimum, Elapsed Time, Event Counter, Total Gallons Pumped, and Clear History?
- 2.2 EXTENDED PUMP RUN STATS (→)
 - i. Extended Pump Run Amps (last event), Average Amps, Maximum Amps, and Minimum Amps
 - ii. Extended Pump Run (last event), Average, Maximum, Minimum, Elapsed Time, Event Counter, Total Gallons Pumped, and Clear History?
- 2.3 HIGH AMP STATS (→)
 - i. High Amp Amps (last event), Average Amps, Maximum Amps, and Minimum Amps
 - ii. High Amp (last event), Average, Maximum, Minimum, Elapsed Time, Event Counter, and Clear History?
- 2.4 PUMP FLOAT STATS (→)
 - i. Pump Float Event Counter and Clear History?
- 2.5 RELAY STATS (→)
 - i. Relay Event Counter and Clear History?
- 2.6 DOSE ON STATS* (→)
 - i. Dose On (last event), Average, Maximum, Minimum, Elapsed Time, Event Counter, and Clear History?
- 2.7 PEAK ON STATS* (→)
 - i. Peak On (last event), Average, Maximum, Minimum, Elapsed Time, Event Counter, and Clear History?
- 2.8 HIGH LEVEL ALARM STATS (→)
 - i. High Level Alarm (last event), Average, Maximum, Minimum, Elapsed Time, Event Counter, and Clear History?
- 2.9 FILTER ALARM STATS (→)
 - i. Filter Alarm (last event), Average, Maximum, Minimum, Elapsed Time, Event Counter, and Clear History?
- 2.10 PUMP FAIL STATS (→)
 - i. Pump Fail (last event), Average, Maximum, Minimum, Elapsed Time, Event Counter, and Clear History?
- 2.11 RELAY FAIL STATS (→)
 - i. Relay Fail (last event), Average, Maximum, Minimum, Elapsed Time, Event Counter, and Clear History?
- 2.12 SYSTEM FAIL STATS** (→)
 - i. System Fail (last event), Average, Maximum, Minimum, Elapsed Time, Event Counter, and Clear History?
- 2.13 POWER LOSS STATS (→)
 - i. Power Loss Event Counter and Clear History?

3.0 | SETTINGS

- 3.1 PASSWORD; factory set to 1919, required for settings menu (change password; enter 1919, press menu, arrow to password, enter value 0000-9999, press menu)
- 3.2 NORMAL LED OFF? or NORMAL LED ON?; press menu button to accept question
- 3.3 PUMP RUN LED OFF? or PUMP RUN LED ON?; press menu button to accept question
- 3.4 SILENCE TIME (→); right arrow to the current setting (factory set to 24:00:00)
- 3.5 EXTENDED PUMP RUN TIME (→); right arrow to the current setting (factory set to 00:30:00)
- 3.6 HIGH AMP LEVEL (→); right arrow to the current setting (factory set to 15.0)
- 3.7 GALLONS PER MINUTE (→); right arrow to the current setting (factory set to 000.0)
- 3.8 DEMAND DOSE? or TIMED DOSE?; press menu button to accept question
- 3.9 INLINE FLOAT? or FLOAT INPUT?**; press menu button to accept question
- 3.10 NORMAL DOSE OFF TIME* (→); right arrow to the current setting (factory set to 10 seconds)
- 3.11 NORMAL DOSE ON TIME* (→); right arrow to the current setting (factory set to 5 seconds)
- 3.12 PEAK DOSE OFF TIME* (→); right arrow to the current setting (factory set to 10 seconds)
- 3.13 PEAK DOSE ON TIME* (→); right arrow to the current setting (factory set to 5 seconds)
- 3.14 MINIMUM PEAK DOSE CYCLES* (→); right arrow to the current setting (factory set to 1)
- 3.15 FINISH DOSE? or STOP DOSE?; press menu button to accept question
- 3.16 BUZZER DELAY* (→); right arrow to the current setting (factory set to 20 seconds)

4.0 | LIFETIME HISTORY

(information on page 59)

(*) Indicates statistic or setting for Timed Dose only

(**) Indicates statistic or setting for Demand Dose only

Menu System Flow (text only; continued)

4.0 | LIFETIME HISTORY

- 4.1 Pump Run Stats (→)
 - i. Pump Run Amps (last event), Average Amps, Maximum Amps, and Minimum Amps
 - ii. Pump Run (last event), Average, Maximum, Minimum, Elapsed Time, Event Counter, and Total Gallons Pumped
- 4.2 Extended Pump Run Stats (→)
 - i. Extended Pump Run Amps (last event), Average Amps, Maximum Amps, and Minimum Amps
 - ii. Extended Pump Run (last event), Average, Maximum, Minimum, Elapsed Time, Event Counter, and Total Gallons Pumped
- 4.3 High Amp Stats (→)
 - i. High Amp Amps (last event), Average Amps, Maximum Amps, and Minimum Amps
 - ii. High Amp (last event), Average, Maximum, Minimum, Elapsed Time, and Event Counter
- 4.4 Pump Float Stats (→)
 - i. Pump Float Event Counter
- 4.5 Relay Stats (→)
 - i. Relay Event Counter
- 4.6 Dose On Stats* (→)
 - i. Dose On (last event), Average, Maximum, Minimum, Elapsed Time, and Event Counter
- 4.7 Peak On Stats* (→)
 - i. Peak On (last event), Average, Maximum, Minimum, Elapsed Time, and Event Counter
- 4.8 High Level Alarm Stats (→)
 - i. High Level Alarm (last event), Average, Maximum, Minimum, Elapsed Time, and Event Counter
- 4.9 Filter Alarm Stats (→)
 - i. Filter Alarm (last event), Average, Maximum, Minimum, Elapsed Time, and Event Counter
- 4.10 Pump Fail Stats (→)
 - i. Pump Fail (last event), Average, Maximum, Minimum, Elapsed Time, and Event Counter
- 4.11 Relay Fail Stats (→)
 - i. Relay Fail (last event), Average, Maximum, Minimum, Elapsed Time, and Event Counter
- 4.12 System Fail Stats** (→)
 - i. System Fail (last event), Average, Maximum, Minimum, Elapsed Time, and Event Counter
- 4.13 Power Loss Stats (→)
 - i. Power Loss Event Counter

(*) Indicates statistic for Timed Dose only OR (**) Indicates statistic for Demand Dose only

General Operation

The Power Post™ Control Panel allows for easy connection of pump power, pump control float switch, in-line pump float switch (optional), high level alarm float switch, and filter switch. The system includes an integrated outdoor alarm equipped with LED indicators (various colors), buzzer, and test/silence pushbutton. The top of the enclosure cover changes color along with system function displayed text on the OLED screen for easy troubleshooting information. View program settings and data such as: pump cycle counts, elapsed time, total gallons pumped, pump dosing events, alarm conditions, and more. The applications are not limited to what is listed in this user guide. Follow all individual instructions for float switches and accessories used with the Power Post™ Control Panel.

The following application can be found in this user guide: Septic Tank Monitoring using Control and Filter Switches (demand dose), Septic Tank Monitoring using Pump, Control, and Filter Switches (demand dose), and Septic Tank Monitoring using Control and Filter Switches (timed dose).

Timed Dosing - The system operates based on the programmed time settings using control and/or pump switches to operate the pump for specified time intervals which controls the on and off time of each pump cycle.

- i. Mitigates variations or peaks in wastewater flow
- ii. Provides a constant volume per dose even if water is entering the tank while the pump is running
- iii. Need enough storage so wastewater can be distributed evenly throughout the day
- iv. Commonly found in systems that include advanced pretreatment or flow equalization
- v. Useful to detect leaks that can otherwise go unnoticed
- vi. Better for non-ideal soil conditions which allows the soil to rest and re-aerate between pump cycles
- vii. Costs more than demand dose but is a better configuration for the soil and pump

Demand Dosing - The system operates based on liquid level demand using control and/or pump switches to operate the pump for each pump cycle.

- i. Pump will run when water is present to activate the pump control float
- ii. Dose volume varies if water enters the tank while the pump is running
- iii. Dose volume depends on the tether length of the pump control float

Power Post™ Control Panel - USER GUIDE

Septic Tank Monitoring | Control and Filter Switch Operated (Demand Dose)

The diagram below displays the typical setup for septic tank monitoring. The setup includes: Power Post™ Control Panel, pump control float switch, alarm float switch, and filter switch. The Power Post™ is installed into the ground and attached to the septic tank riser. The pump power is wired into the enclosure terminals. When the pump control float switch is actuated, the pump will turn on and turn back off when the pump control float switch is deactivated.

The alarm float switch is wired to a sensor input. When the alarm float switch is actuated, the top cover of the enclosure will flash red and the buzzer will annunciate. The alarm condition will stay on until the alarm float switch is deactivated. If the silence pushbutton is pressed during an alarm condition, the top cover of the enclosure remains flashing red and the buzzer will silence. The silence condition will reset when the alarm float switch deactivates. If the alarm is in silence mode for longer than 24 hours, the alarm will reactivate.

The filter switch is wired to a sensor input. When the filter switch is actuated the top cover of the enclosure will flash amber and the buzzer will annunciate. The alarm condition will stay on until the effluent filter has been serviced/cleaned and the filter switch is deactivated. If the silence pushbutton is pressed during an alarm condition, the top cover of the enclosure remains flashing amber and the buzzer will silence. The silence condition will reset when the filter switch deactivates. If the alarm is in silence mode for longer than 24 hours, the alarm will reactivate.

Use the menu keys to view data for: pump cycle counts, pump elapsed time, total gallons pumped, high level alarm counter with elapsed time, filter alarm counter with elapsed time, silence time setting, and much more.

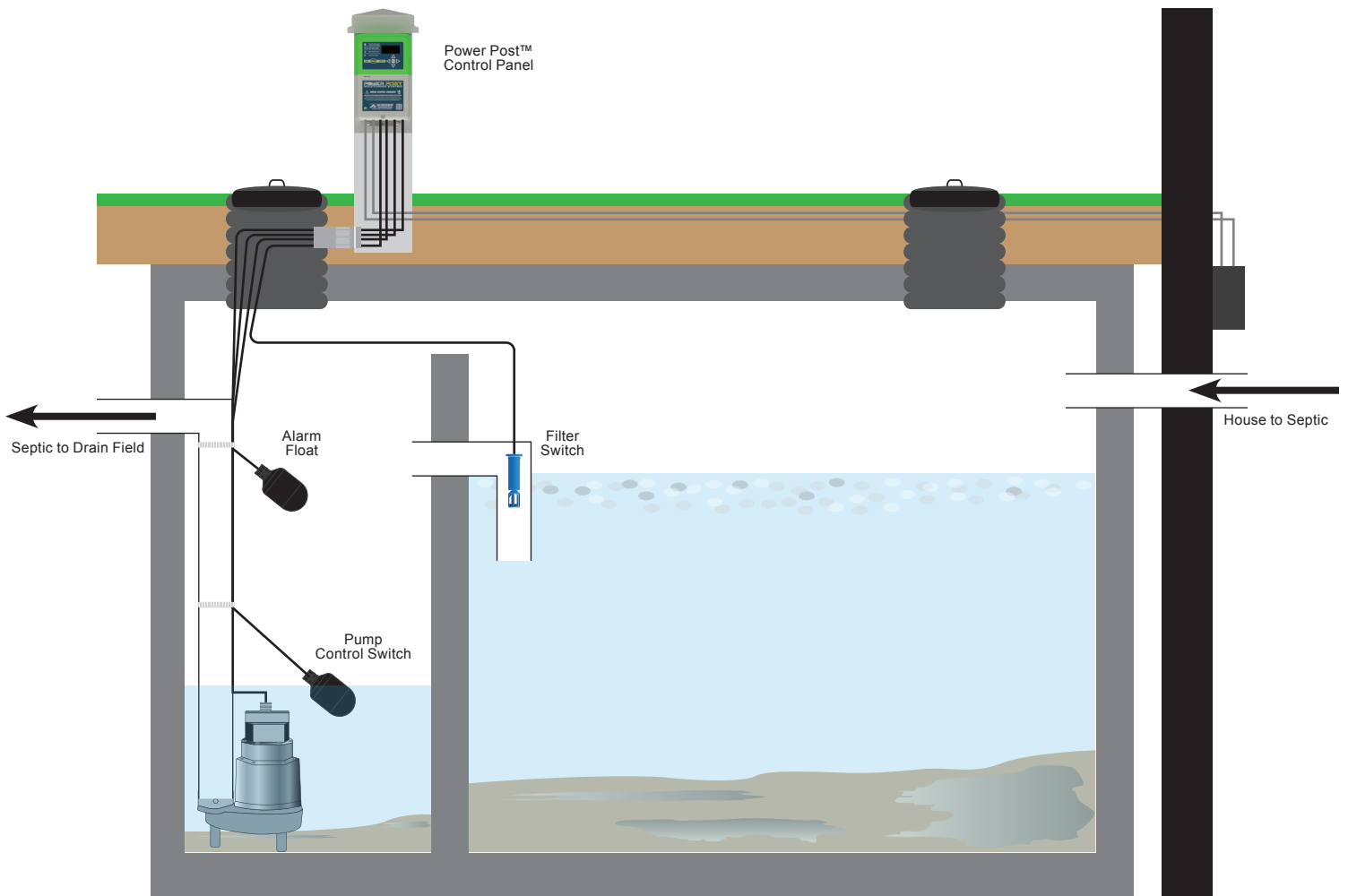

Septic Tank Monitoring | Pump, Control, and Filter Switch Operated (Demand Dose)

The diagram below displays the typical setup for septic tank monitoring. The setup includes: Power Post™ Control Panel, in-line pump float switch, alarm float switch, and filter switch. The Power Post™ is installed into the ground and attached to the septic tank riser. The pump is plugged into the piggyback plug of the in-line pump float switch. When the in-line pump float switch is actuated, the pump will turn on and turn back off when the in-line pump float switch is deactivated.

The alarm float switch is wired to a sensor input. When the alarm float switch is actuated, the top cover of the enclosure will flash red and the buzzer will annunciate. The alarm condition will stay on until the alarm float switch is deactivated. If the silence pushbutton is pressed during an alarm condition, the top cover of the enclosure remains flashing red and the buzzer will silence. The silence condition will reset when the alarm float switch deactivates. If the alarm is in silence mode for longer than 24 hours, the alarm will reactivate.

The filter switch is wired to a sensor input. When the filter switch is actuated the top cover of the enclosure will flash amber and the buzzer will annunciate. The alarm condition will stay on until the effluent filter has been serviced/cleaned and the filter switch is deactivated. If the silence pushbutton is pressed during an alarm condition, the top cover of the enclosure remains flashing amber and the buzzer will silence. The silence condition will reset when the filter switch deactivates. If the alarm is in silence mode for longer than 24 hours, the alarm will reactivate.

Use the menu keys to view data for: pump cycle counts, pump elapsed time, total gallons pumped, high level alarm counter with elapsed time, filter alarm counter with elapsed time, silence time setting, and much more.

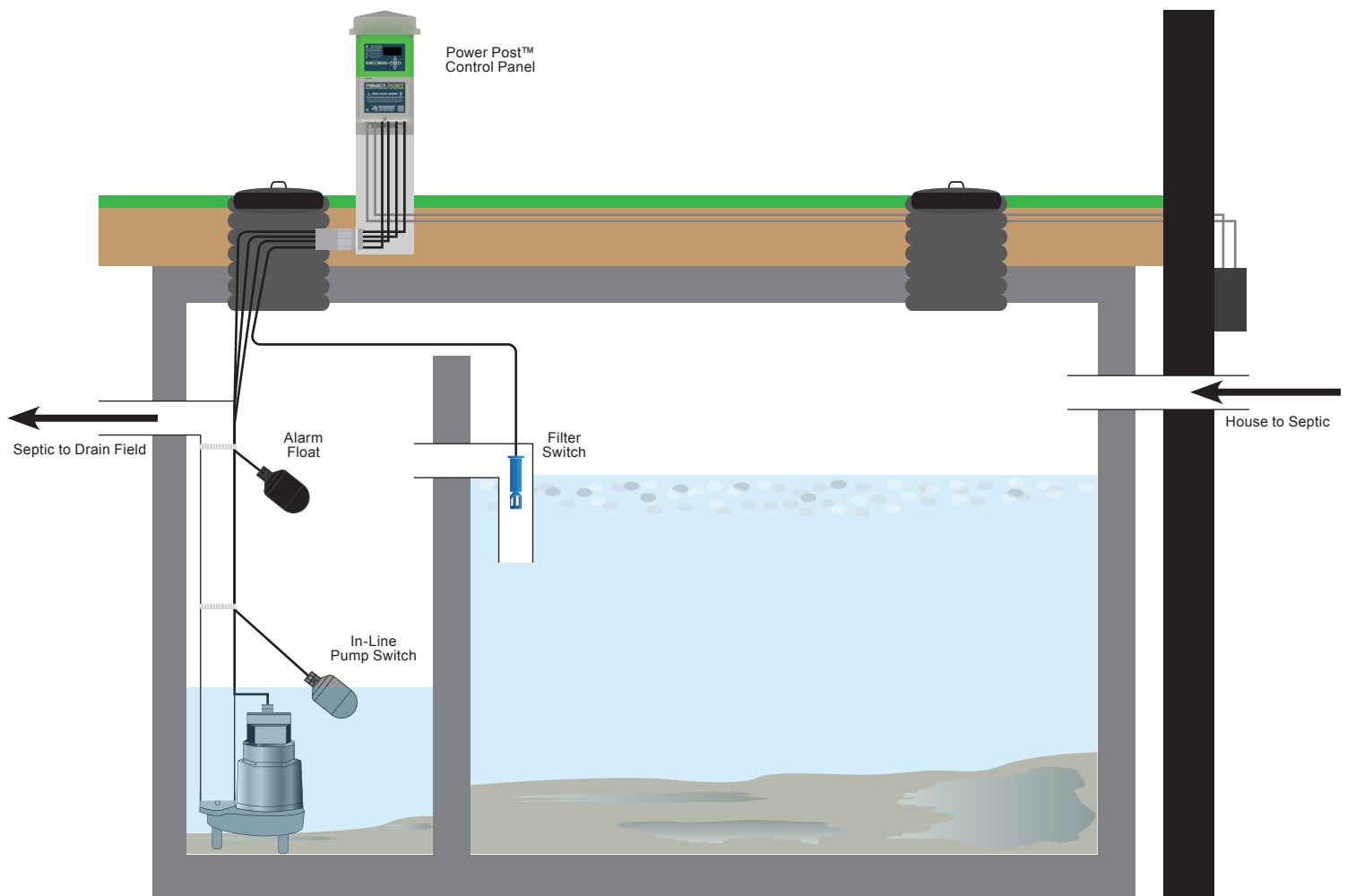

Power Post™ Control Panel - USER GUIDE

Septic Tank Monitoring | Control and Filter Switch Operated (Timed Dose)

The diagram below displays the typical setup for septic tank monitoring. The setup includes: Power Post™ Control Panel, pump control float switch, alarm float switch, and filter switch. The Power Post™ is installed into the ground and attached to the septic tank riser. The pump power is wired into the enclosure terminals. When the pump control float switch is actuated, the pump will turn on and turn back off when the pump control float switch is deactivated. The pump control float switch is used to activate and deactivate the timed dose pump cycles using normal dose on/off time and peak dose on/off time settings.

The alarm float switch is wired to a sensor input. When the alarm float switch is actuated, the top cover of the enclosure will flash red and the buzzer will annunciate. The alarm condition will stay on until the alarm float switch is deactivated. If the silence pushbutton is pressed during an alarm condition, the top cover of the enclosure remains flashing red and the buzzer will silence. The silence condition will reset when the alarm float switch deactivates. If the alarm is in silence mode for longer than 24 hours, the alarm will reactivate.

The filter switch is wired to a sensor input. When the filter switch is actuated the top cover of the enclosure will flash amber and the buzzer will annunciate. The alarm condition will stay on until the effluent filter has been serviced/cleaned and the filter switch is deactivated. If the silence pushbutton is pressed during an alarm condition, the top cover of the enclosure remains flashing amber and the buzzer will silence. The silence condition will reset when the filter switch deactivates. If the alarm is in silence mode for longer than 24 hours, the alarm will reactivate.

Use the menu keys to view data for: pump cycle counts, pump elapsed time, total gallons pumped, pump dosing events, high level alarm counter with elapsed time, filter alarm counter with elapsed time, silence time setting, and much more.

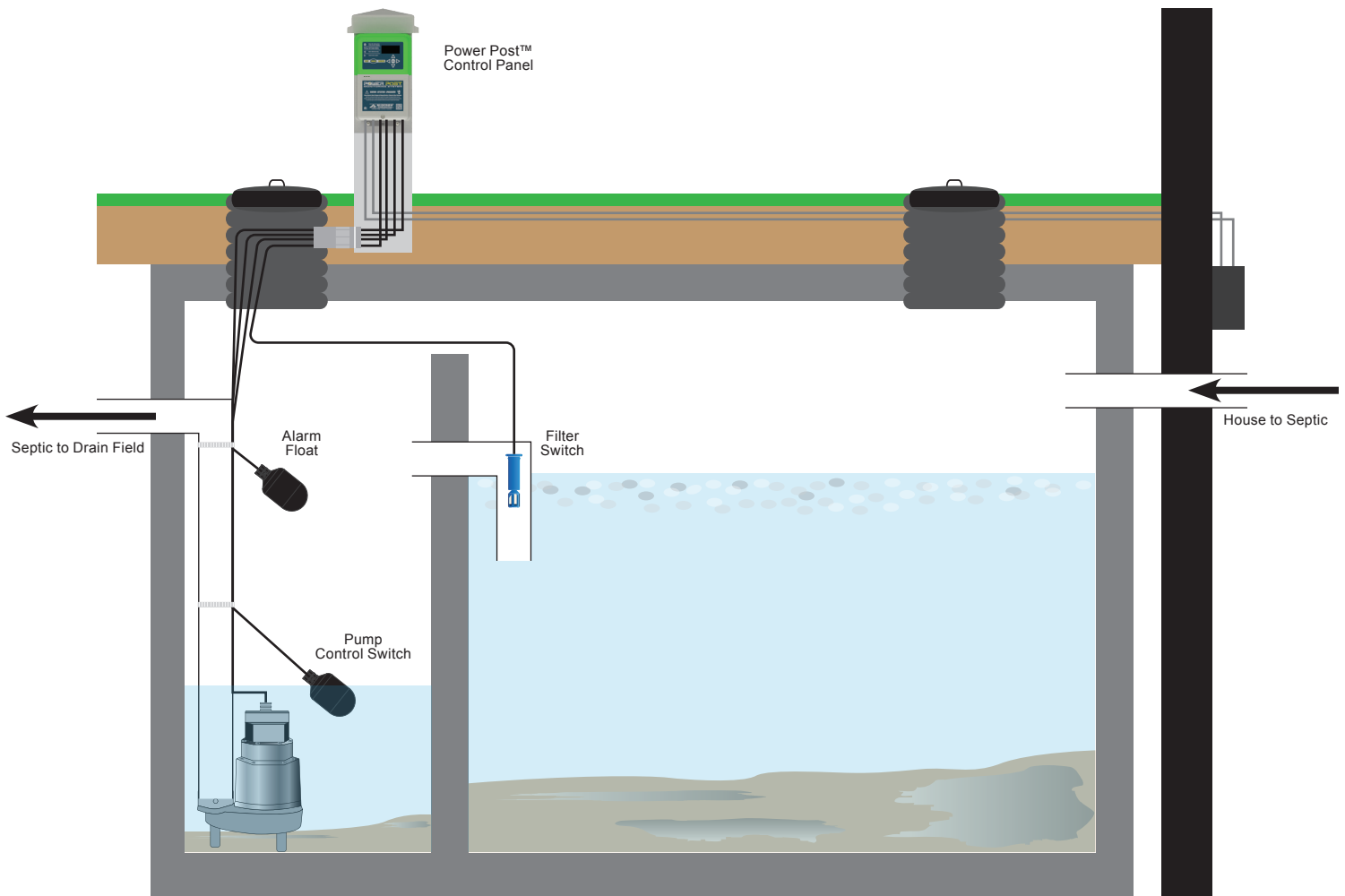

Troubleshooting

PROBLEM	PROBABLE CAUSE	SOLUTION
Green LEDs on the enclosure are not turning on during initial setup	Power not applied or power loss	Check to see if unit is plugged in, have qualified personnel check receptacle with voltmeter and make sure circuit breaker is not tripped; during a power loss event the OLED screen will display PWR LOSS ALARM (page 21)
	Green LED turn off feature activated	See page 32 for programming LED on and off feature
The pump is running continuously	Check to see if the control or pump float switch is hung up on something	Make sure the control or pump float switch is free and the line is tethered at desired location in a secure fashion
	If the control or pump float switch is old, the contacts could be stuck shut	Replace the control or pump float switch
	Broken discharge pipe	Repair or replace discharge pipe
	The control relay contacts are stuck shut	Replace the control relay (page 11)
The pump is drawing high amps	Check to make sure there's no damage to the pump and it's operating properly	Service or replace the pump
	Check to see if there are any blockages to the pump	Clear blockage to resume normal pump operation
The pump is not drawing amps	Check to make sure there's no damage to the pump and it's operating properly	Service or replace the pump
	Check to see if the pump float switch is hung up on something	Make sure the pump float switch is free and the line is tethered at desired location in a secure fashion
	If the pump switch is old, the contacts could be stuck open	Replace the pump float switch
While using an alarm float switch, the alarm conditions are resuming with an empty tank	Check to see if the alarm float switch is hung up on something	Make sure the alarm float switch is free and the line is tethered at desired location in a secure fashion
	If the alarm float switch is old, the contacts could be stuck shut	Replace the alarm float switch
The alarm float switch is activated, the red LEDs on the enclosure are flashing and the buzzer is not annunciating	The test/silence pushbutton has been pressed	Deactivate or disconnect the alarm float switch and then reactivate or reconnect the alarm float switch to ensure normal operation resumes (pages 9 and 27)
The alarm float switch is activated, the white and cyan LEDs on the enclosure are alternating every second and the buzzer is annunciating	A float failure event has occurred, check to see if the pump control and alarm float switches are wired properly	Refer to pages 8 and 9 for detailed wiring and testing information
	Check to see if the pump control float switch is hung up on something	Make sure the pump float switch is free and the line is tethered at desired location in a secure fashion
	The pump control float switch is old, the contacts could be stuck open	Replace the pump control float switch

Power Post™ Control Panel - USER GUIDE

Troubleshooting (continued)

PROBLEM	PROBABLE CAUSE	SOLUTION
While using a filter switch, the alarm conditions are resuming with a clean effluent filter	Check to see if the filter switch has debris or material build up	Clean filter switch enclosure and float to resume normal operation
The filter switch is activated, the amber LEDs on the enclosure are flashing and the buzzer is not annunciating	The test/silence pushbutton has been pressed	Deactivate or disconnect the filter switch and then reactivate or reconnect the filter switch to ensure normal operation resumes (pages 20 and 27)
The system fail statistics are not displayed in either resettable or lifetime history menus	The system has been programmed to timed dosing	Program system for demand dosing, refer to page 33 for system settings
The dose on and peak on statistics are not displayed in either resettable or lifetime history menus	The system has been programmed to demand dosing	Program system for timed dosing, refer to page 33 for system settings
The white LEDs on the enclosure are flashing, the buzzer is not annunciating, and SYSTEM OVERRIDE appears on the screen	The hand-off-auto pump selector has been switched to system override mode for manual operation of the pump	Program system to automatic pump mode, refer to pages 13, 25, and 29 for detailed information
The white and cyan LEDs on the enclosure are alternating every second, no text is displayed on the OLED screen, and alarm buzzer is not annunciating	The faceplate or OLED screen are not properly connected to the main circuit board (UI Error event)	Make sure the ribbon from the faceplate to the main circuit board has a secure connection, consult factory if the error remains after checking ribbon

Specifications

Pump Power Receptacle:	120VAC or 240VAC, 15A, 60 Hz (voltage depends on model/part number)
Pump Power:	120VAC or 240VAC, 13A or 15A, 60 Hz (voltage/amps depends on model/part number)
<hr/>	
Alarm Power:	120VAC, 60 Hz (240VAC, 60 Hz available; consult factory)
Power Consumption:	14 Watts maximum (alarm condition)
Enclosure:	Outdoor, rated Type 3R
Certifications:	FCC Part 15 (US and Canada), CSA (US and Canada)

FCC Part 15:

NOTE: This equipment has been tested and found to comply with the limits for a Class B digital device, pursuant to part 15 of the FCC Rules. These limits are designed to provide reasonable protection against harmful interference in a residential installation. This equipment generates, uses and can radiate radio frequency energy and, if not installed and used in accordance with the instructions, may cause harmful interference to radio communications. However, there is no guarantee that interference will not occur in a particular installation. If this equipment does cause harmful interference to radio or television reception, which can be determined by turning the equipment off and on, the user is encouraged to try to correct the interference by one or more of the following measures: increase the separation between the equipment and receiver, connect the equipment into an outlet on a circuit different from that to which the receiver is connected, consult the dealer or an experienced radio/TV technician for help. Caution: changes / modifications not approved by Alderon Industries could void the user's authority to operate the equipment.

Model Number Nomenclature

PPCP1315A2

1 2 3 4 5 6

NUMBER	CATEGORY	TYPE / EXAMPLE
1	Base Model	PPCP = Power Post™ Control Panel, Timed or Demand Dose, Outdoor Alarm
2	Pump Voltage	1 = 120VAC Pump 2 = 240VAC Pump
3	Alarm Options	X = No Alarm Option 1 = 15' Alarm Float 2 = 20' Alarm Float 3 = 15' Alarm Float and 15' Filter Switch 4 = 20' Alarm Float and 20' Filter Switch
4	Pump Control Float Options <i>Timer Enable or Pump On/Off</i> (operates pump)	X = No Pump Control Float Option 1 = 15' Wide Angle Control Float 2 = 20' Wide Angle Control Float 3 = 15' Medium Angle Control Float 4 = 20' Medium Angle Control Float
5	In-Line Pump Switch Options <i>Pump On/Off or Redundant Off</i> (piggyback plug models)	X = No Pump Switch Option 5C = 13 Amp, 15' Wide Angle Pump Switch 6C = 13 Amp, 20' Wide Angle Pump Switch 7C = 13 Amp, 15' Medium Angle Pump Switch 8C = 13 Amp, 20' Medium Angle Pump Switch 5A = 15 Amp, 15' Wide Angle Pump Switch 6A = 15 Amp, 20' Wide Angle Pump Switch 7A = 15 Amp, 15' Medium Angle Pump Switch 8A = 15 Amp, 20' Medium Angle Pump Switch
6	Riser Kit and Access Panel Options	X = No Riser Kit or Access Panel Option 1 = 2.0" Riser Connection Kit 2 = 2.5" Riser Connection Kit X1 = No Riser Kit with Access Panel 11 = 2.0" Riser Connection Kit with Access Panel 21 = 2.5" Riser Connection Kit with Access Panel

Example Shown: Power Post™ Control Panel, 120VAC, 15' Alarm Float, 15' Filter Switch, 15' Wide Angle Control Float, 15A 15' Wide Angle Pump Switch, 2.5" Riser Connection Kit

Warranty Information

Three-Year Limited Warranty - Standard Products

LIMITED WARRANTY: Subject to the conditions of this Three-Year Limited Warranty, Alderon Industries, LLC (“Alderon”) warrants to the original user or consumer of an Alderon product (the “Product”) that, for a period of three (3) years from the date of manufacture, the Product will be free from defects in materials and workmanship under normal use and service, and provided the Product is installed, operated and maintained in accordance with instructions supplied by Alderon.

WARRANTY EXCLUSIONS: Notwithstanding anything to the contrary, this Limited Warranty does not cover:

1. Alderon custom control units. Please see the One-Year Limited Warranty – Custom Controls.
2. Damage, defects or malfunctions resulting from (a) failure to properly install, operate or maintain the Product in accordance with printed instructions provided and with applicable local codes, ordinances and good trade practices; (b) normal wear and tear; (c) abuse, accident or negligence; (d) de-installation and movement of the Product from its original installation location; (e) repair and/or modification of the Product without prior authorization from Alderon; (f) use of the Product for purposes other than for what it was designed and manufactured; or (g) conditions beyond the control of Alderon, including lightning and freight damages (hidden or visible). **Contact parcel or the freight company for claims on freight damage in transit.**
3. Cost of field labor or other charges incurred by you in removing and/or re-affixing the Product or any part or component thereof.
4. Transportation costs.

CLAIM PROCEDURE: To make a claim regarding breach of warranty, (a) the claim must be received by Alderon before the expiration of the warranty period; and (b) the defective Product, or part thereof, must be returned to a designated Alderon location, **FREIGHT PREPAID**, together with proof of purchase. A return goods authorization must be received prior to the return of the defective Product or part. Please contact the sales representative in your area to determine the designated Alderon location for return and to obtain the return goods authorization. If you do not have a sales representative in your area, please call 218-483-3034 to submit your claim, or mail notice of your claim to:

Warranty Claims
Alderon Industries, LLC
P.O. Box 827
Hawley, MN 56549

EXCLUSIVE REMEDY: In the event of a warranty claim that Alderon determines to be covered by this Limited Warranty, Alderon will, at its option, repair or replace the Product.

The above limited warranty and this exclusive remedy are the sole express warranty and remedy given by Alderon on the Product. No warranties or representations at any time made by any representative from Alderon shall vary or expand the provisions hereof. TO THE EXTENT PERMITTED BY LAW, ALL EXPRESS AND IMPLIED WARRANTIES (INCLUDING IMPLIED WARRANTIES OF MERCHANTABILITY, FITNESS FOR A PARTICULAR PURPOSE AND NON-INFRINGEMENT) OTHER THAN THE EXPRESS LIMITED WARRANTY SET FORTH ABOVE ARE EXPRESSLY DISCLAIMED. UPON THE EXPIRATION OF THE ABOVE STATED LIMITED WARRANTY PERIOD, ANY AND ALL APPLICABLE IMPLIED WARRANTIES, INCLUDING, WITHOUT LIMITATION, WARRANTIES OF MERCHANTABILITY, FITNESS FOR A PARTICULAR PURPOSE AND NON-INFRINGEMENT, ARE DISCLAIMED. SOME STATES DO NOT ALLOW LIMITATION ON HOW LONG AN IMPLIED WARRANTY LASTS, SO THE ABOVE LIMITATION MAY NOT APPLY TO YOU.

THIS WARRANTY GIVES YOU SPECIFIC LEGAL RIGHTS AND YOU MAY ALSO HAVE OTHER RIGHTS, WHICH VARY FROM STATE TO STATE.

LIABILITY LIMITATION: In no event will Alderon’s liability to you or any other person or entity exceed the price paid to Alderon for the defective Product. IN NO EVENT SHALL ALDERON BE LIABLE TO YOU OR ANY OTHER PERSON OR ENTITY FOR INCIDENTAL, CONSEQUENTIAL, INDIRECT OR SPECIAL DAMAGES OF ANY DESCRIPTION, WHETHER ARISING OUT OF WARRANTY (INCLUDING ANY IMPLIED WARRANTIES) OR ANY OTHER CONTRACT, STRICT LIABILITY, NEGLIGENCE OR OTHER TORT, OR OTHERWISE, INCLUDING ARISING FROM INSPECTION OR REMEDY DELAYS. SOME STATES DO NOT ALLOW THE EXCLUSION OR LIMITATION OF INCIDENTAL OR CONSEQUENTIAL DAMAGES, SO THE ABOVE LIMITATION AND EXCLUSION MAY NOT APPLY TO YOU.



UG00292_Rev08_PPCCP_Power Post Control Panel | November 14, 2022 10:29 AM

Company Location: 151 16th Street South, Hawley, MN 56549
Mailing Address: PO Box 827, Hawley, MN 56549
Main Office Phone: 218.483.3034
Website: alderonind.com
General Inquiry Email: info@alderonind.com
Submit New Orders: orders@alderonind.com